

User Manual

E217

REMARK

Please follow the user manual for correct installation and testing. If there is any doubt please call our tech-supporting and customer center.

Our company applies ourselves to reformation and innovation of our products. No extra notice for any change. The illustration shown here is only for reference. If there is any difference, please take the actual product as the standard.

The product and batteries must be handled separately from household waste. When the product reaches the end of service life and needs to be discarded, please contact the local administrative department and put it in the designated collection points in order to avoid the damage to the environment and human health caused by any disposal. We encourage recycling and reusing the material resources.

CATALOG

PRODUCT FEATURE	1
TECHNICAL PARAMETER	1
PACKAGE CONTENT	2
OVERVIEW	3
BASIC OPERATION	4
DEVICE SETTING	13
WEB SETTING	20
SYSTEM DIAGRAM	36
DEVICE WIRING	37
INSTALLATION	40
TROUBLESHOOTING	42
SAFETY INSTRUCTION	43

PRODUCT FEATURE

1. 7-inch capacitive touch screen
2. Powered by PoE or power adapter (DC12V/2A)
3. Dual network ports optional
4. Support WiFi
5. Support monitoring 8 IP cameras
6. Support TF card

TECHNICAL PARAMETER

System: Linux

Front Panel: Plastic

Power Supply: PoE (802.3af) or DC 12V/2A

Standby Power: 2 W

Rated Power: 9 W

Ethernet Port: 1 x RJ45, 10/100 Mbps adaptive

Resolution: 1024 x 600

Working Temperature: -10°C to +55°C

Storage Temperature: -40°C to +70°C

Working Humidity: 10% to 90% (non-condensing)

PACKAGE CONTENT

MODEL: E217



E217



Wiring Cover



PM4×20 (2 pcs)



Diode (8 pcs)



Wires



Quick Start Guide



Desktop Stand
(Optional)

OVERVIEW

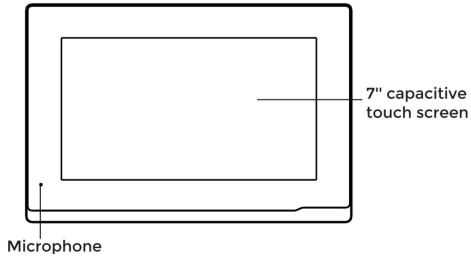

E217 Overview



7" Capacitive Touch Screen
with 1024 x 600 Resolution



PoE Power Supply



Support RS485



8-channel Alarm Inputs



Dimensions:
195 x 130 x 14.5mm



2.4GHz Wi-Fi



TF Card



Optional Dual Ethernet Ports

BASIC OPERATION

1. Call

Go to Dial and enter Building number + Building + Unit number + Unit + Room number + dial icon to call Indoor Monitor (such as 1 + Building + 1 + Unit + 1111 + Dial button). Or you can press Concierge here to call Master Station.

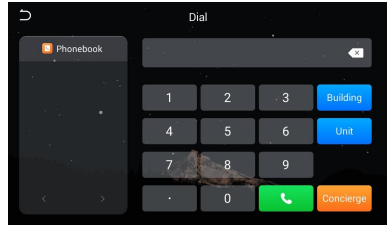
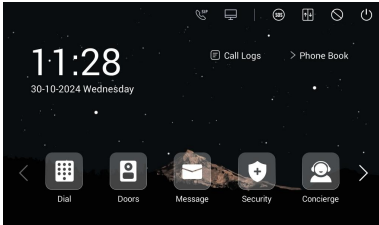

2. Doors

Click Doors icon on Indoor Monitor's homepage to monitor Door Station. You can unlock by clicking door icon or switch to monitor other devices by clicking arrow or the name above.

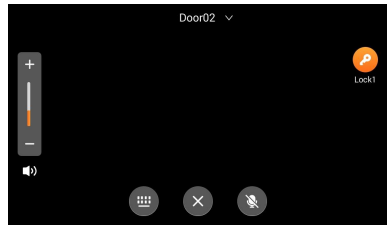
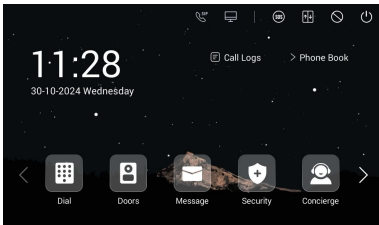

3. Message

Indoor Monitor can receive the messages sent by the CMS, Master Station or Indoor Monitor. Up to 64 records can be received in SMS.

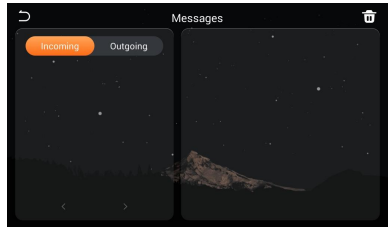
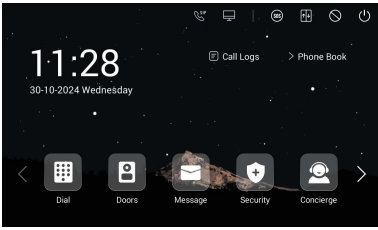

Click + icon on Outgoing page. Users can send message to Indoor Monitor or Master Station. Before sending message, users need to fill in the receiver's IP address on Indoor Monitor webpage (Concierge IP in Intercom > Call column).

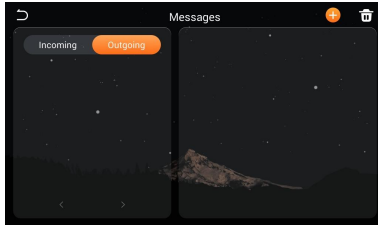

4. DND

Click DND icon on the right upper corner to enable do not disturb function. No calls can call in. Users can set DND to turn on whole day or a period of time.

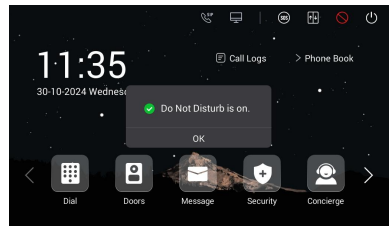
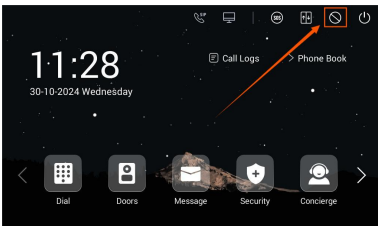

5. Security

Security is for sensors. The default password is 1234.

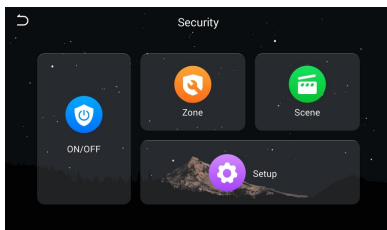

5.1.ON/OFF

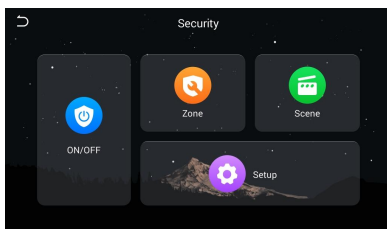

ON:	Click Out, Home, or Sleep icon to activate the scene for alarm sensors, the icon on the main interface will light up with a beep sound;
OFF:	Click OFF to disable scene;

5.2.Zone

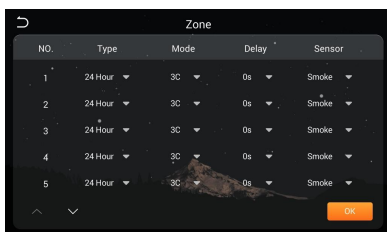

Type:	<ul style="list-style-type: none"> • Normal: When users enable an alarm scene on the On/Off page, Normal type alarm zone will be activated after activation time. <ul style="list-style-type: none"> ○ 100 seconds is the default activation time, it means the alarm will be activated after 100 seconds. ○ After 100s, once sensor is triggered, Indoor Monitor will send this alarm to Master
-------	--------------------------------------------------------------------------------------------------------------------------------------------------------------------------------------------------------------------------------------------------------------------------------------------------------------------------------------------------------------------------------------------------------------------------------------------------------

	<p>Station.</p> <ul style="list-style-type: none"> ○ But sometimes users don't want to send the alarm to Master Station (maybe alarm by mistake), users can set the Delay time, so they can cancel the alarm in the Indoor Monitor during this Delay time (PIR, Door, Window); ● Emergency: once Panic button is triggered, Indoor Monitor will not initiate an alarm and only Master Station will receive alarms secretly; 24 hours standby even if the security is off (Panic, Pull Cord); ● 24 Hour: Indoor Monitor will initiate an alarm and Master Station will also receive alarms. 24 hours standby even if the security is off (Smoke, Gas, Flood);
Mode:	<ul style="list-style-type: none"> ● 3C: for the sensor with 2.2KΩ resistance; Regardless of the connection to NC or NO, the alarm can be triggered normally; ● NO: normally open; ● NC: normally closed; ● BELL: in BELL mode, Master Station will not receive any alarm. Indoor Monitor is regarded as a doorbell receiver;
Delay:	Once sensor is triggered, Indoor Monitor will send this alarm to Master Station, but users can terminate the alarm sending to Master Station during the delayed time set here. Delay setting is only effective for Normal type (0s, 5s, 15s, 20s, 25s, 40s, 60s);
Sensor:	Sensor types (Smoke, Gas, PIR, Door, Window, Panic, Flood, Pull Cord);

5.3.Scene

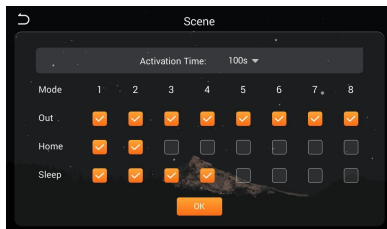

Activation Time:	Only after activation time, will scene be activated. Activation time is only effective for Normal type (NONE, 30s, 40s, 60s, 100s, and 300s);
Mode:	Tick to link sensors to Out, Home, or Sleep scene;

5.4.Setup

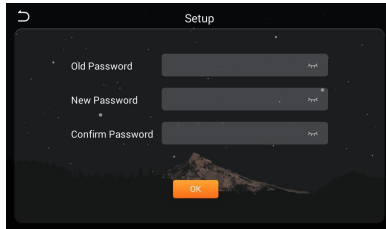

Old:	Current security password of the Device (Default 123456);
New:	New security password of the Device;
Confirm:	Confirm security password of the Device;

6. Concierge

Press the Concierge icon to call Master Station one by one.

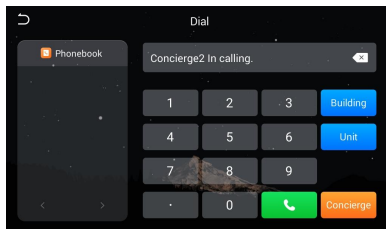

7. Cameras

On the 2nd homepage, click Cameras. Up to 8 IPC can be added. The device supports adding IPC devices via ONVIF or RTSP stream. Tap the button located in the top-right corner to open a pop-up window for adding an IPC

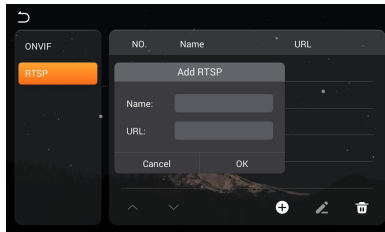
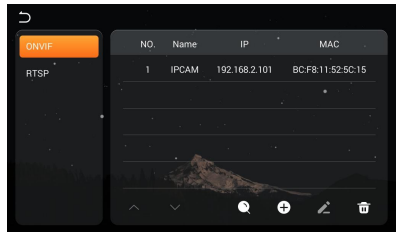
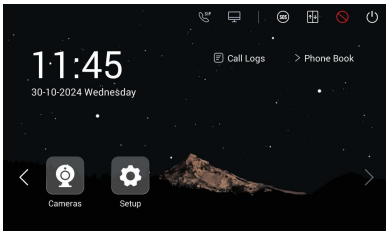

Once the camera is successfully added, you can preview the video.

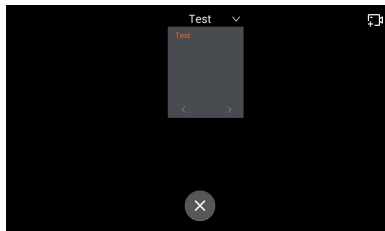

8. Phonebook

Click phone Book.

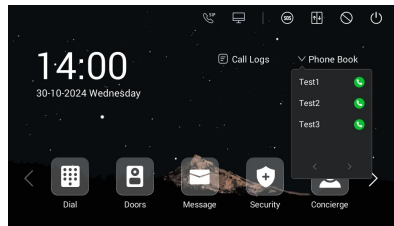
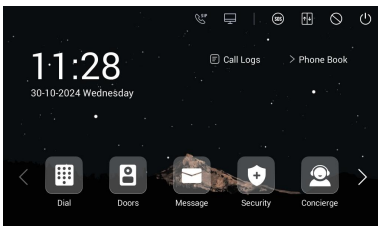

Or go to Dial > Phonebook. Select the name on the phonebook and press dial button to call.

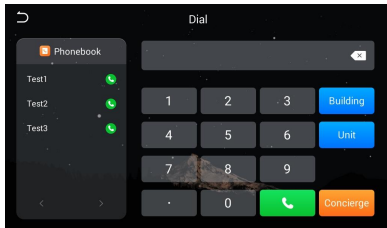
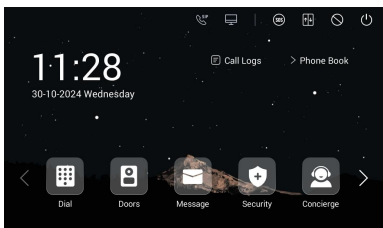

9. QR Code

Click QR Code and scan by Smart Life app to add this Indoor Monitor to your phone. Only when the license is filled in Internet-connected Indoor Monitor, QR code will be available.

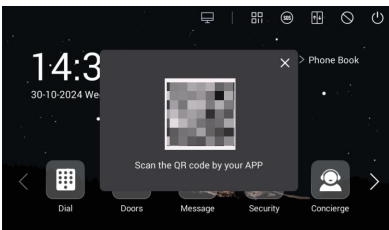
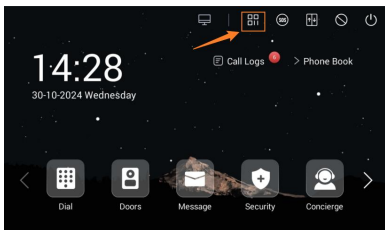

10. Elevator

Press the Elevator icon to control elevator (DNAKE Elevator Control Module is needed).

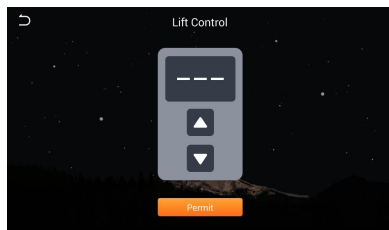
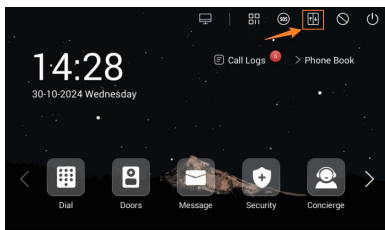

11. Add More Indoor Monitors

Keep Building, Unit, Apartment No., Sync the same as other Indoor Monitors, and Device number should be different. The Device number can be from 0 to 9. But

you must have one Indoor Monitor's Device number is 0 and keep it online because 0 here stands for the main one.

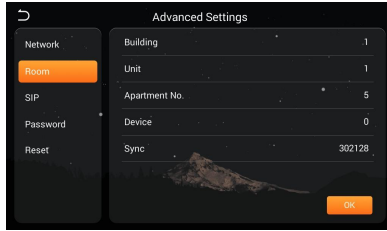

Or go to Indoor Monitor's webpage and find Ex Phone in Intercom > Call. Users can directly extend to more Indoor Monitors by filling in sip:IP address (6 Max) such as sip:192.168.68.90. (Please refer to WEB SETTING for the way to access to webpage)

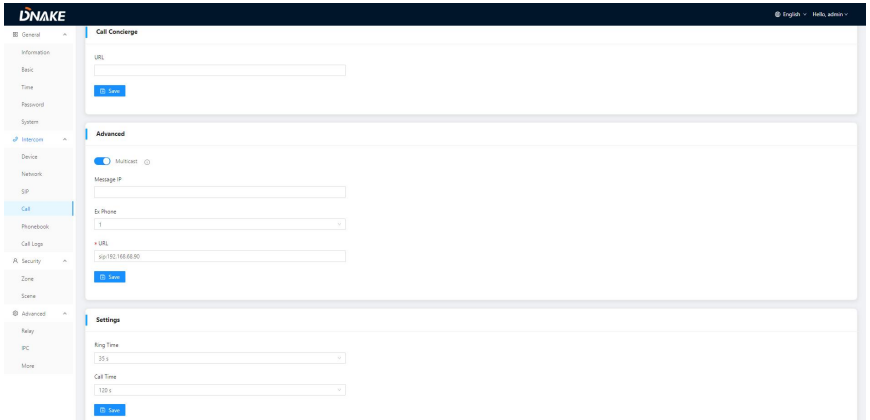

12. SIP Setting

Users can directly configure SIP on the device's Setup > More > SIP page.

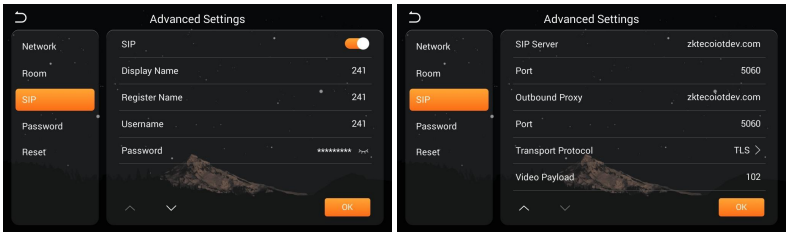

13. SOS

Users can press SOS icon on the right upper corner to send SOS to Master Station. Users can set the trigger time length on the webpage. If the time is set to 3s, users need to press the SOS icon for 3s to send out SOS in case of a wrong operation alarm.

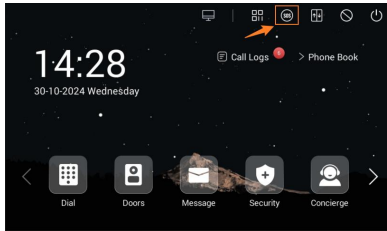

14. Screen Lock

Users can lock the screen by enabling Screen Lock on the device's Setup > General > Display page. The screen will be locked after screen off timeout (Unlock password is the security password. The default password is 1234).

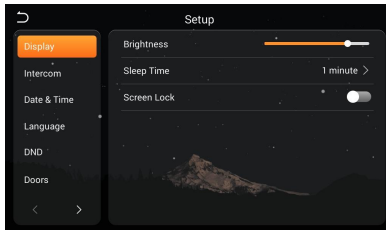

DEVICE SETTING

1. General

1.1. Display

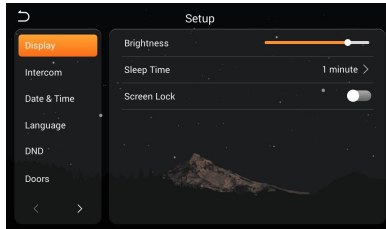

Brightness:	Screen brightness adjustment;
Sleep Time:	Screen sleep time (15s, 30s, 1min, 2mins, 5mins, 20mins, 30mins);
Screen Lock:	The screen will be locked after screen off timeout (Unlock password is security password. The default password is 1234);

1.2. Intercom

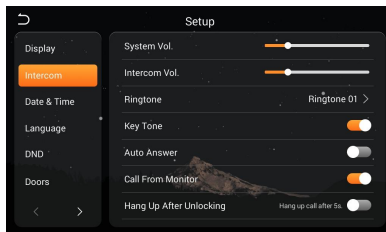

System Vol:	Volume of System can be set from 1 to 6. Volume 6 is the maximum volume (Key tone);
Intercom Vol:	Volume of Intercom can be set from 1 to 6. Volume 6 is the maximum volume (Call volume);
Ringtone:	The ringing sound (Ringtone 01-04);
Key Tone:	The keytone (Enable or disable);
Call From Monitor:	Enable to receive the call from other indoor monitors.
Auto Answer:	Pick up automatically when receiving a call;

Hang Up After Unlocking:	Hang up automatically after unlocking doors.
--------------------------	----------------------------------------------

1.3. Date & Time

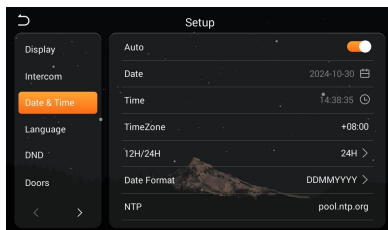

Auto:	Enable to synchronize computer time;
Date&Time:	Date and time can be set manually;
Time Zone:	A region that observes a uniform standard time;
12H/24H:	Select 12H or 24H format to display on the device;
Date Format:	3 time formats supported (YYYY-MM-DD, DD-MM-YYYY, MM-DD-YYYY);
NTP:	Network Time Protocol (NTP) is a protocol used to synchronize NTP time;

1.4. Language



Language:	16 languages supported (简体中文, English, 繁體中文, עברית, Deutsch, Español, Türk, Tiếng Việt, Nederlands, Português, Polski, Русский, عربي, Français, Italiano, slovenský);
-----------	-----------------------------------------------------------------------------------------------------------------------------------------------------------------------

2. WIFI

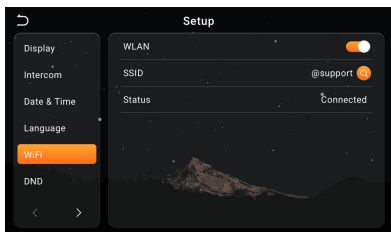

WLAN:	Enable to use WiFi;
SSID:	Select WiFi to connect;
Status:	The status of WiFi.

3. DND

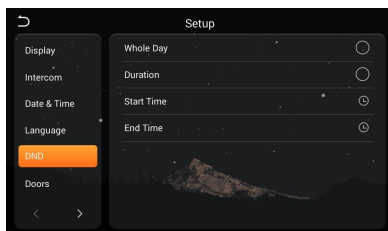

DND:	DND is disabled by default. Whole Day: when DND is enabled, it will reject calls for the whole day. Duration: when DND is enabled, it will reject calls during this time.
------	---------------------------------------------------------------------------------------------------------------------------------------------------------------------------------

4. Doors

You need to click search icon to add Door Stations to Indoor Monitor and click Save to save before monitoring. Click funnel icon to pin the selected device to the top. Click pen icon to edit devices.

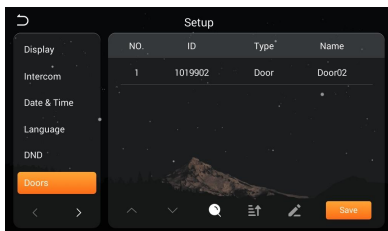

5. Reboot

You can click “OK” to reboot indoor monitor.

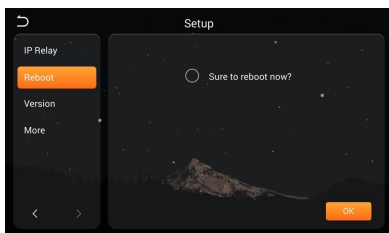

6. Version

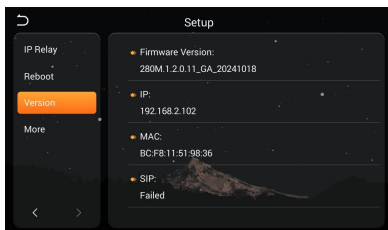

Firmware Version:	Firmware version of the device;
IP:	Current IP address of the device;
MAC:	MAC address of the device;
WiFi IP:	Current WiFi IP address of the device;
SIP:	Status of SIP registration of the device;

7. More > Network

The device network can be set to either DHCP or a static IP address. CMS parameters should be configured here when you try to register this device to CMS.

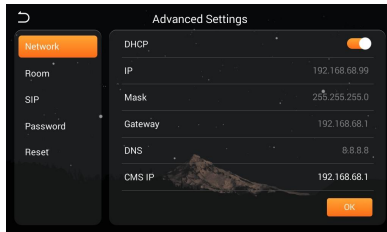

DHCP:	Enable DHCP (Dynamic Host Configuration Protocol) to dynamically distributing network configuration parameters;
IP:	Configure Static IP address to manually distributing network configuration parameters;
Mask:	Subnet mask;
Gateway:	A component that is part of two networks, which use different protocols;
DNS:	Domain Name Server of the device;
CMS IP:	Server address of CMS;

8. More > Room

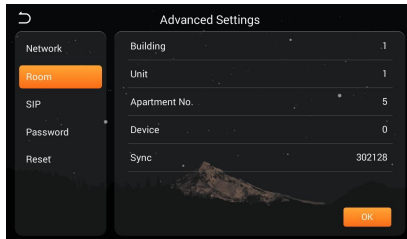

Building:	Number of the building (Range: 1-999);
Unit:	Number of the unit (Range: 0-99);
Apartment No.:	Number of the apartment (Range: 0-9899);
Device:	Number of the device (Range: 0-9);
Sync:	A number used to synchronize to other Indoor Monitors;

9. More > SIP

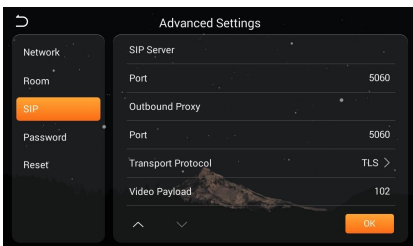
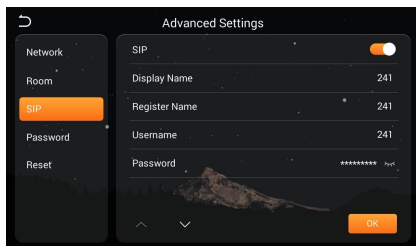

SIP:	Enable to use SIP;
Display Name:	Display name of SIP account;
Register Name:	Register Name of SIP account;
Username:	Username of SIP account;
Password:	Password of SIP account;
SIP Server Host:	Directly fill in SIP server's address e.g., 192.168.68.90; The default port is 5060;
Outbound Proxy:	Outbound Proxy server; the default port is 5060;
Transport Protocol:	Transport Protocol (UDP, TCP, TLS);
Video Payload:	Video payload range is 96-127;

10. More > Password

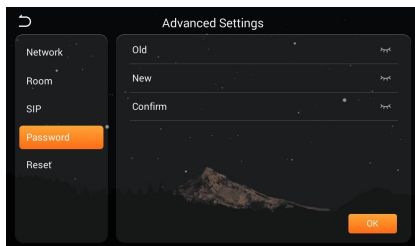

Old Password:	Current administrator password of the Device (Default 123456);
New Password:	New administrator password of the Device;
Confirm Password:	Confirm administrator password of the Device;

11. More > Reset

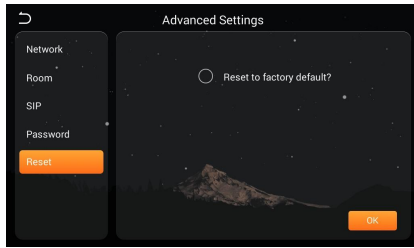

Reset:	Reset to factory default;
--------	---------------------------

WEB SETTING

Connect Indoor Monitor and PC to a network switch in the same LAN. You can enter the IP address of Indoor Monitor in the web browser search bar and log in with the default account (admin) and password (123456). This is where you can configure the device.

To get the IP address, you can search by Remote Upgrade Tool installed in the same LAN with the devices.

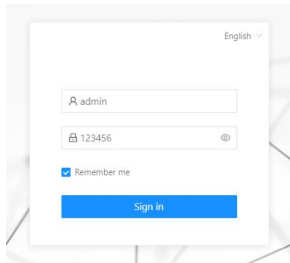

1. General

1.1.General > Information

When you first log in to the web interface, you can find basic information displayed in this dashboard.

Product			
Model	E217	Firmware Version	160M.1.1.0.14_A_20230915
MAC Address	BCFB:11:01:08:02		
WiFi MAC	FC:EE:E6:47:8D:78	Firmware	1.6.0 20230915
UI	1.1.0 20230915 16M		

Network			
DHCP	Enabled	IP Address	192.168.68.100
Mask	255.255.255.0		
Gateway	192.168.68.1	DNS	192.168.98.198

SIP Account			
Account	5004	Status	Register Success
IMS IP	192.168.68.1	Status	Register Failed

Model:	Model of the device;
Firmware Version:	Firmware version of the device;
MAC Address:	MAC address of the device;
Framework:	Framework of the device;
UI:	UI of the device;
DHCP:	Status of DHCP;
IP Address:	Current IP address of the device;
Mask:	Subnet mask of the device;
Gateway:	Gateway of the device;
DNS:	Domain Name Server of the device;
Account:	SIP account of the device;
Status:	Status of SIP registration of the device;
CMS IP:	IP address of CMS;
Status:	Status of CMS registration;

1.2.General > Basic

Some basic settings of the device can be configured in this column.

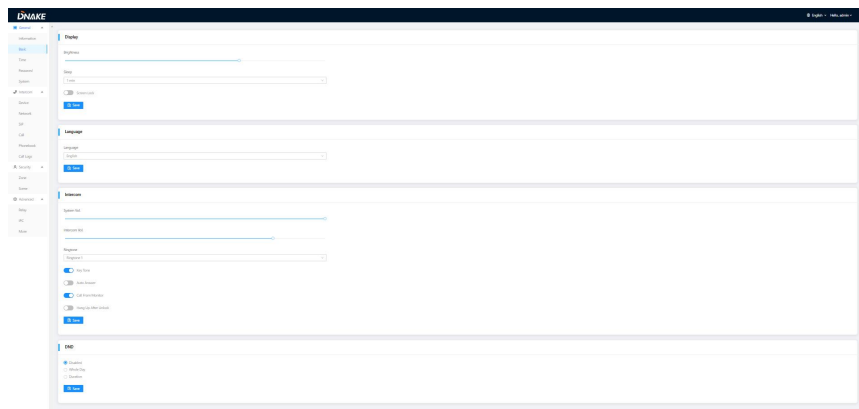

Brightness:	The brightness of the screen;
Sleep:	Screen off timeout (15s, 30s, 1min, 2mins, 5min s, 10mins, 30mins);
Screen Lock:	The screen will be locked after screen off timeout (Unlock password is security password. The def

	ault password is 1234);
Language:	16 languages supported (简体中文, English, 繁體中文, עברית, Deutsch, Español, Türk, Tiếng Việt, Nederlands, Português, Polski, Русский, عربي, Français, Italiano, slovenský);
System Vol:	Volume of System can be set from 1 to 6. Volume 6 is the maximum volume (Key tone);
Intercom Vol:	Volume of Intercom can be set from 1 to 6. Volume 6 is the maximum volume (Call volume);
Ringtone:	The ringing sound (Ringtone 01-04);
Key Tone:	The keytone (Enable or disable);
Auto Answer:	Pick up the phone automatically when receiving a call;
Call From Monitor:	Enable to receive the call from other indoor monitors.
Hang Up After Unlocking:	Hang up automatically after unlocking doors.
DND:	DND is disabled by default. Whole Day: when DND is enabled, it will reject calls for the whole day. Duration: when DND is enabled, it will reject calls during this time.

1.3.General > Time

Time of the device can be configured. Daylight Saving Time is also supported.

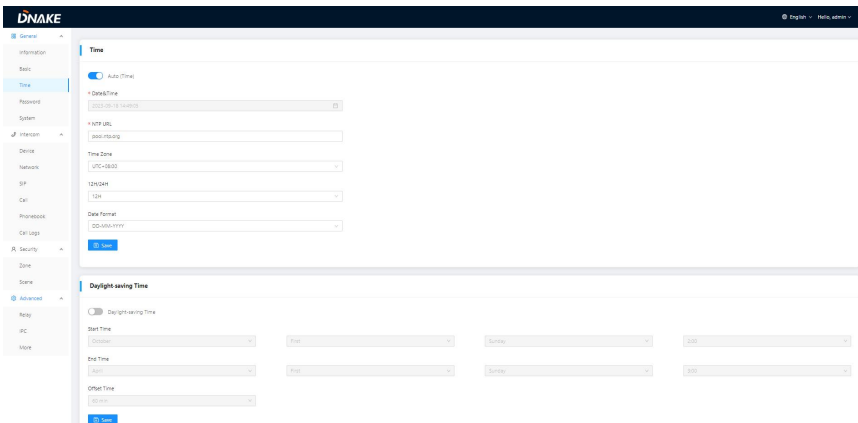

Auto (Time):	Enable to synchronize computer time;
Date&Time:	Date and time can be set manually;

NTP URL:	Network Time Protocol (NTP) is a protocol used to synchronize NTP time;
Time Zone:	A region that observes a uniform standard time;
12H/24H:	Select 12H or 24H format to display on the device;
Date Format:	3 time formats supported (YYYY-MM-DD, DD-MM-YYYY, MM-DD-YYYY);
Daylight-saving Time:	Enable to set DST;
Start Time:	The beginning of DST;
End Time:	The ending of DST;
Offset Time:	The default value is 60 minutes;

1.4.General > Password

The System password is for the administrator to log in settings on the device while the Web password is for the administrator to log in settings on the web. The default password for both of them is 123456. User for Indoor Monitor is the security password whose default password is 1234.

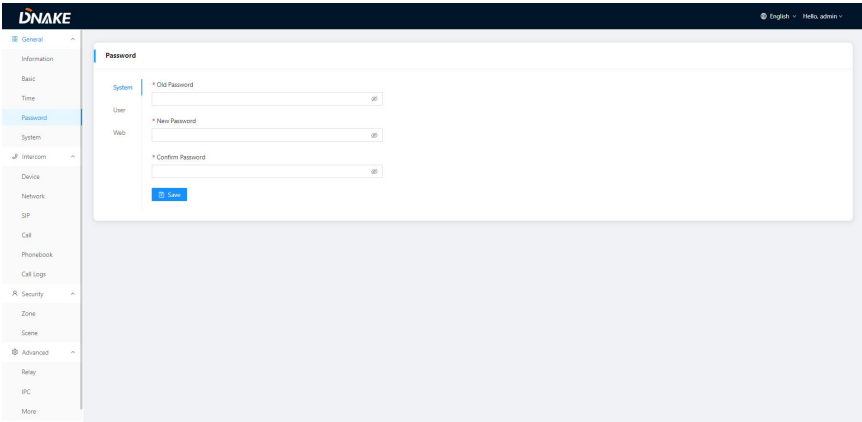

System Old Password:	Current administrator password of the Device (Default 123456);
System New Password:	New administrator password of the Device;
System Confirm Password:	Confirm administrator password of the Device;
User Old Password:	Current security password of the Device (Default 1234);
User New Password:	New security password of the Device;

User Confirm Password:	Confirm security password of the Device;
Web Old Password:	Current administrator password of the web (Default 123456);
Web New Password:	New administrator password of the web;
Web Confirm Password:	Confirm administrator password of the web;

1.5.General > System

The system column is designed for factory default and device reboot.

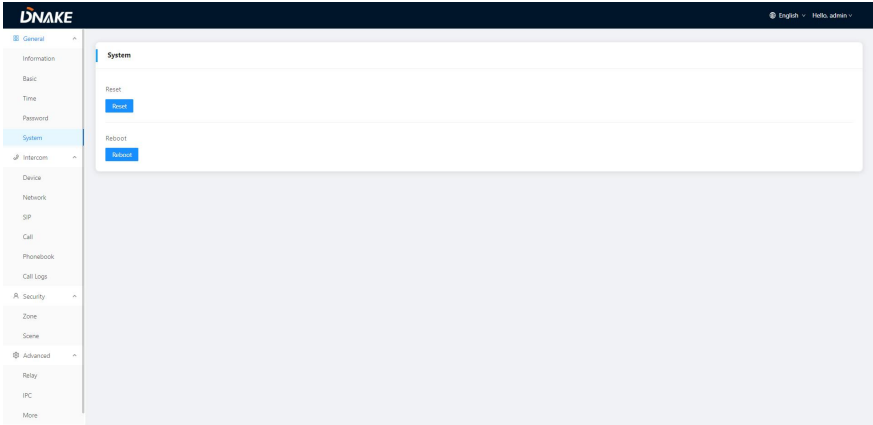

Reset:	Reset to factory settings;
Reboot:	Reboot the device;

2. Intercom

2.1. Intercom > Device

Numbers here are basic settings for making a call to Indoor Monitor. For Door Station, the building and unit number should be the same as those in Indoor Monitor.

For Villa Station with one button, the building, unit, and room number should be the same as those in Indoor Monitor.

When users want to use more than 1 Indoor Monitors, keep Building, Unit, Apartment No., Sync the same as other Indoor Monitors, and Device number

should be different. The Device number can be from 0 to 9. But you must have one Indoor Monitor's Device number is 0 and keep it online because 0 here stands for the main one.

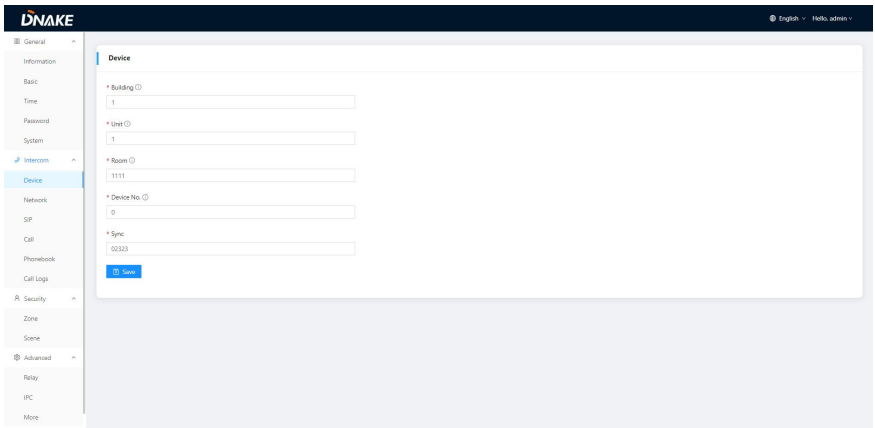

Building:	Number of the building (Range: 1-999);
Unit:	Number of the unit (Range: 0-99);
Room:	Number of the apartment (Range: 0-9899);
Device No:	Number of the device (Range: 0-9);
Sync:	A number used to synchronize to other Indoor Monitors;

2.2. Intercom > Network

The device network can be set to either DHCP or a static IP address. CMS parameters should be configured here when you try to register this device to CMS.

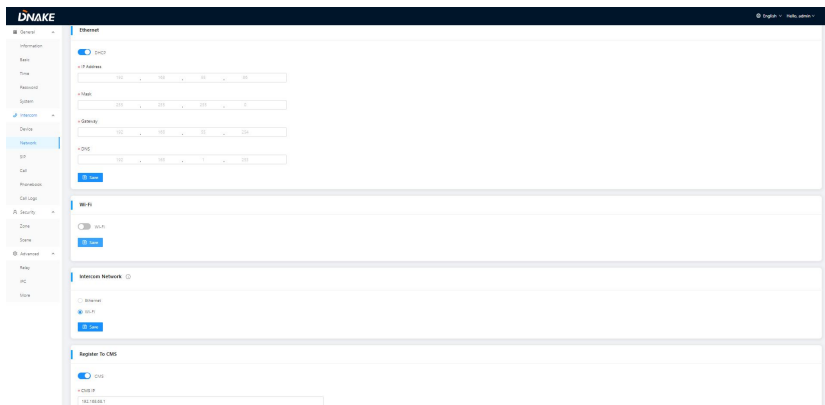

DHCP:	Enable DHCP (Dynamic Host Configuration Protocol) to dynamically distribute network configuration parameters;
IP Address:	Configure Static IP address to manually distribute network configuration parameters;
Mask:	Subnet mask;
Gateway:	A component that is part of two networks, which use different protocols;
DNS:	Domain Name Server of the device;
WiFi:	WiFi can be enabled when you want to use it;
Intercom Network:	When Ethernet/WiFi is selected, the call will use the wired/WiFi network.
CMS:	Enable to use CMS software to manage devices;
CMS IP:	Server address of CMS;

2.3. Intercom > SIP

The SIP column concerns SIP registration, Display Name, Register Name, Username, Password, SIP Server Host, Outbound Proxy, Transport Protocol, Video Payload, etc.

SIP:	Enable to use SIP;
Display Name:	Display name of SIP account;
Register Name:	Register Name of SIP account;
Username:	Username of SIP account;
Password:	Password of SIP account;
SIP Server Host:	Directly fill in SIP server's address e.g., 192.168.68.90; The default port is 5060;
Outbound Proxy:	Outbound Proxy server; the default port is 5060;
Transport Protocol:	Transport Protocol (UDP, TCP, TLS);
Ring Code:	Ring code. Without SDP or with (180 or 183);
Video Payload:	Video payload range is 96-127;

2.4. Intercom > Call

Ring group is for setting up SIP calls or call mode. Concierge button, extension of other Indoor Monitors, the length of the call, and ring time can also be configured here.

Call Concierge URL:	<p>Fill in the call destination for concierge button or the single button on the device;</p> <ul style="list-style-type: none"> ● IP call: Fill in sip:IP address, e.g., sip:192.168.68.90; ● SIP call: Fill in sip:sip account@SIP server address:port, e.g., sip:101@192.168.68.90:5060;
Multicast:	Enable to receive broadcast from Master Station;
Message IP:	Fill in the message receiver's (Indoor Monitor or Master Station) IP address. The message edited on Indoor Monitor will send to this destination;
Ex Phone:	Extend to more Indoor Monitors by filling in sip:IP address (6 Max) such as sip:192.168.68.90 (6 Max);
Ring Time:	The ring will be ended automatically after a period of time (10s, 20s, 35s, 45s, 60s, 90s, 120s)
Call Time:	The call will be ended automatically after a period of time (120s, 300s, 600s, 1200s, 1800s);

2.5. Intercom > Phonebook

All contacts on Indoor Monitor can be edited here.

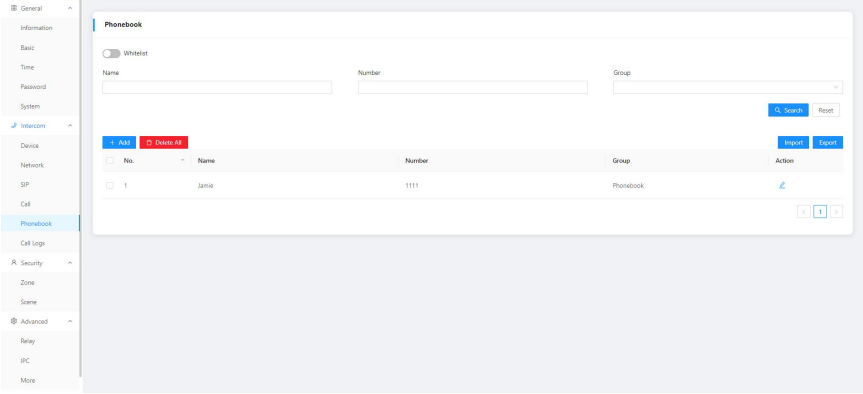

Whitelist:	Enable whitelist to block other calls outside of the whitelist. For example, Ana is in the whitelist but Nyree isn't in it. Ana can call in while Nyree can't;
Search:	Fill in text inputs to search;
Reset:	Click reset to clear words in text inputs;
Add:	Click to add more contacts;
Delete All:	Delete all data on the chart;
Import:	Import all data to the chart;
Export:	Export all data on the chart;

2.6. Intercom > Call Logs

All call logs can be checked here.

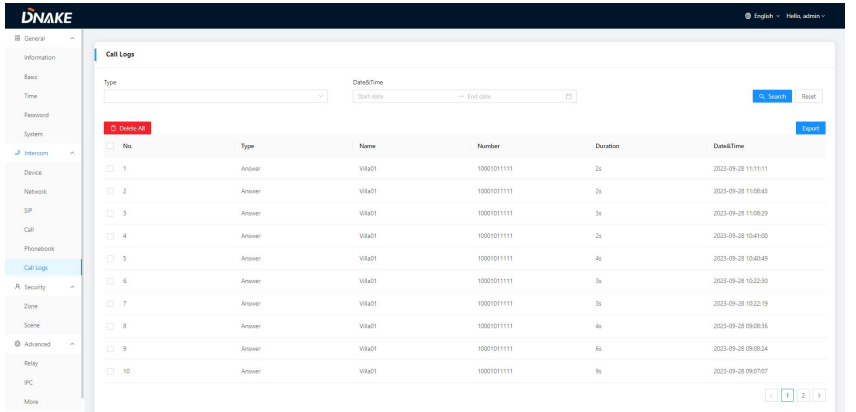

Search:	Fill in text inputs to search;
Reset:	Click reset to clear words in text inputs;
Delete All:	Delete all data on the chart;
Export:	Export all data on the chart;

3. Security

3.1.Security > Zone

Zone column is the setup page for security sensors.

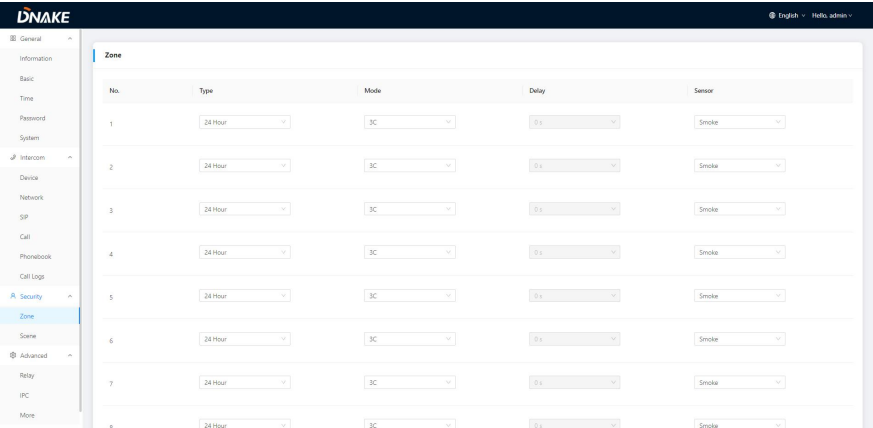

Type:	<ul style="list-style-type: none"> • Normal: When users enable an alarm scene on the On/Off page, Normal type alarm zone will
--------------	----------------------------------------------------------------------------------------------------------------------------------------------

	<p>be activated after activation time.</p> <ul style="list-style-type: none"> ○ 100 seconds is the default activation time, it means the alarm will be activated after 100 seconds. ○ After 100s, once sensor is triggered, Indoor Monitor will send this alarm to Master Station. ○ But sometimes users don't want to send the alarm to Master Station (maybe alarm by mistake), users can set the Delay time, so they can cancel the alarm in the Indoor Monitor during this Delay time (PIR, Door, Window); <ul style="list-style-type: none"> ● Emergency: once Panic button is triggered, Indoor Monitor will not initiate an alarm and only Master Station will receive alarms secretly; 24 hours standby even if the security is off (Panic, Pull Cord); <p>24 Hour: Indoor Monitor will initiate an alarm and Master Station will also receive alarms. 24 hours standby even if the security is off (Smoke, Gas, Flood);</p>
Mode:	<ul style="list-style-type: none"> ● 3C: for the sensor with 2.2KΩ resistance; Regardless of the connection to NC or NO, the alarm can be triggered normally; ● NO: normally open; ● NC: normally closed; <p>BELL: in BELL mode, Master Station will not receive any alarm. Indoor Monitor is regarded as a doorbell receiver;</p>
Delay:	<p>Once sensor is triggered, Indoor Monitor will send this alarm to Master Station, but users can terminate the alarm sending to Master Station during the delayed time set here. Delay setting is only effective for Normal type (0s, 5s, 15s, 20s, 25s, 40s, 60s);</p>
Sensor:	<p>Sensor types (Smoke, Gas, PIR, Door, Window, Panic, Flood, Pull Cord, Bedside);</p>

3.2.Security > Scene

Scene column is for security sensors' trigger conditions.

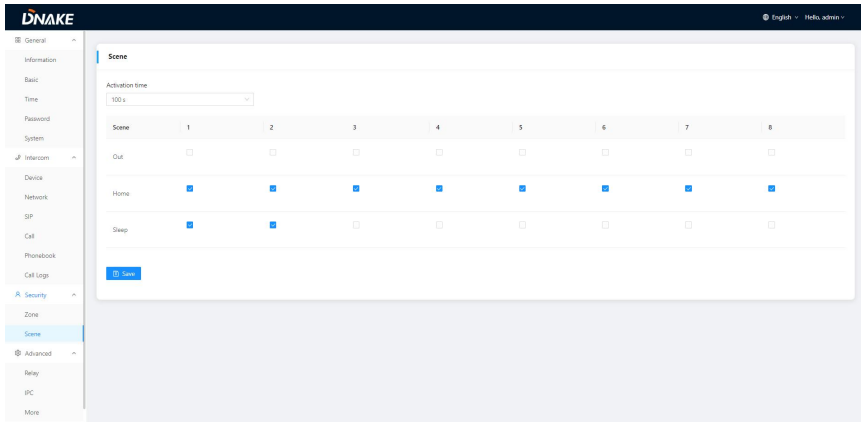

Activation Time:	Only after activation time, will scene be activate d. Activation time is only effective for Normal type (NONE, 30s, 40s, 60s, 100s, and 300s);
Mode:	Tick to link sensors to Out, Home, or Sleep scene;

4. Advanced

4.1. Advanced > Relay

Relay column is for Local Relay and Door Relay.

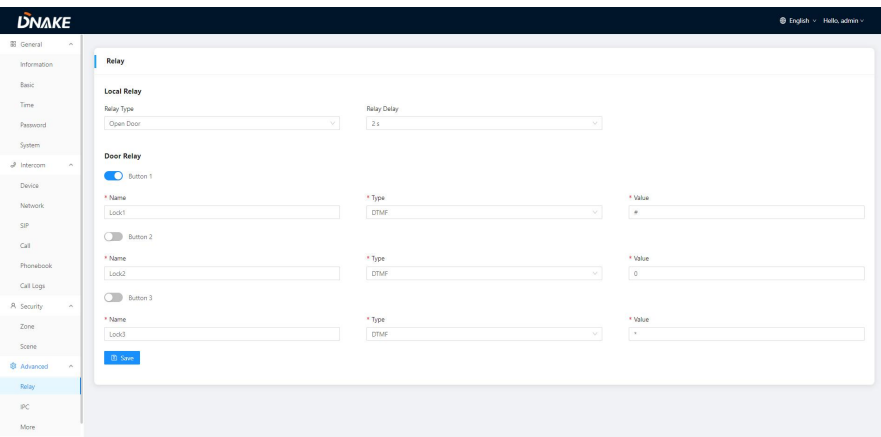

Local Relay Type:	Type of local relay (Open Door is for lock/Chime
-------------------	--------------------------------------------------

	Bell is for doorbell);
Local Relay Delay:	The length of unlock delay time (1-9s);
Unlock Button 1-3:	Enable or disable relays for unlock buttons;
Name:	Customize name for unlock button;
Type:	Type 1-3: 3 types of unlock way are optional (Local Relay/DTMF/HTTP) HTTP—the format is http://192.168.3.119/cgi-bin/webapi.cgi?api=unlock&index=2&username=admin&password=E10ADC3949BA59ABBE56E057F20F883E; Note: <ul style="list-style-type: none"> • "192.168.3.119" is the IP address of Door Station; • The number "2" after "index=" is the number for relay. (Relay 1 is 0; relay 2 is 1; relay 3 is 2); • "admin" here should be changed to your admin account; • "Password" is Password of admin; • "E10ADC3949BA59ABBE56E057F20F883E" here is MD5 (Message-Digest Algorithm) encrypted. Users need to use account password to encrypt and change it. DTMF—Dual-tone multi-frequency signaling, Relay1: #, Relay2:0, relay3: *;

4.2.Advanced > IPC

You can enter the IP address of Indoor Monitor in the web browser search bar and log in with the default account (user) and password (1234). This is where you can add IPC.

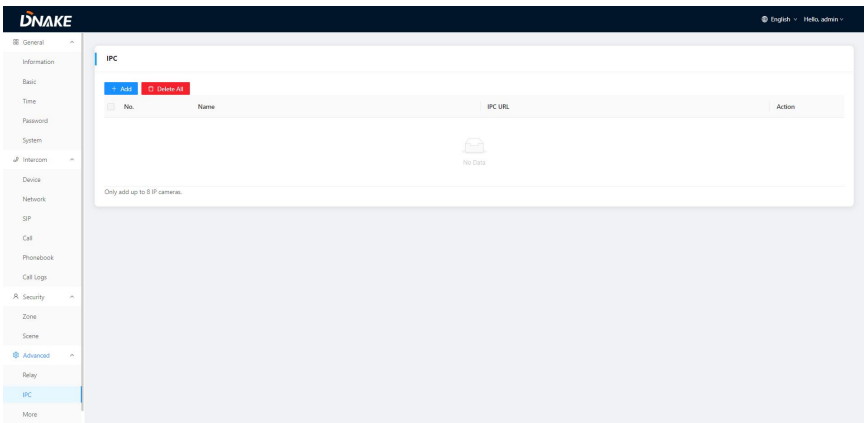

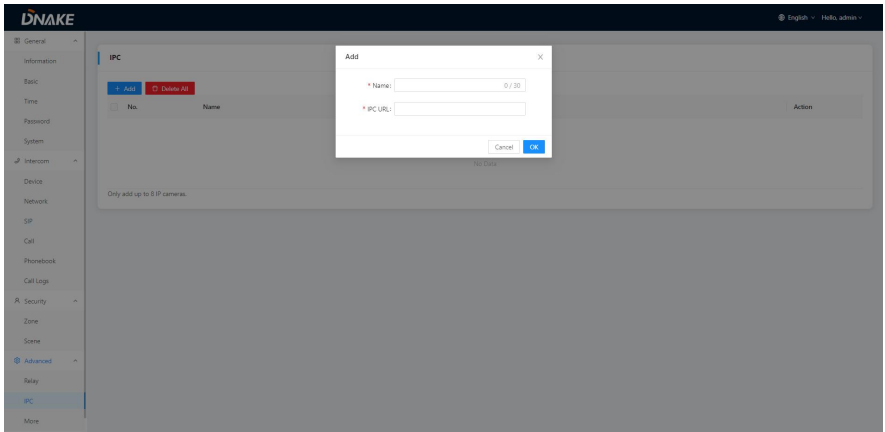

Name:	Customize name of IPC;
IPC URL:	Fill in IPC's RTSP stream;

4.3.Advanced > More

More column is for SOS and Wallpaper.

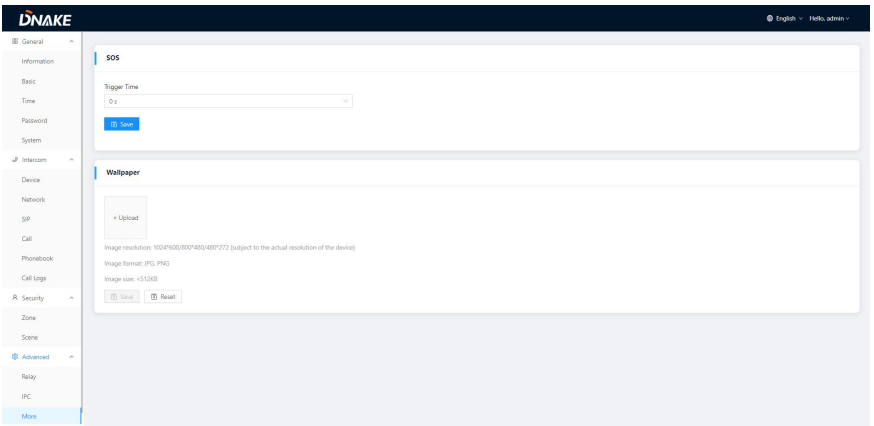

SOS:	Trigger Time can be set to 0s and 3s. If the time is set to 3s, users need to press the SOS icon for 3s to send out SOS in case of a wrong operation alarm.;
Wallpaper:	Upload a picture to apply it to the device UI.

	<p>Please make sure the picture's resolution is the same as the device's and the size of the picture should be lower than 512KB. The format of Picture should be JPG or PNG;</p>
--	----------------------------------------------------------------------------------------------------------------------------------------------------------------------------------

SYSTEM DIAGRAM

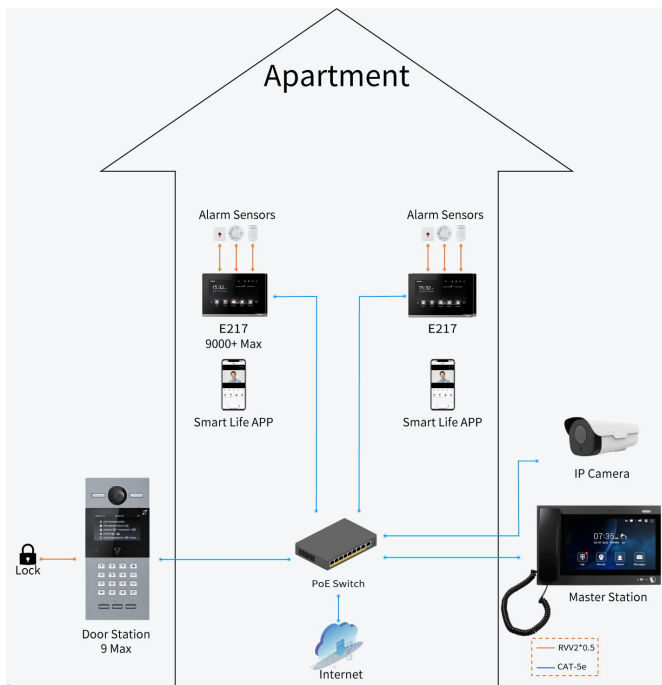

DEVICE WIRING

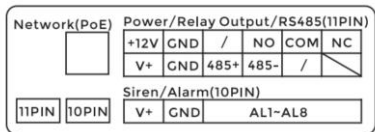

Single Port

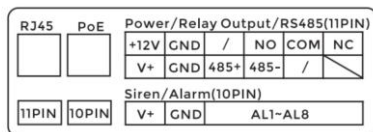

Dual Port

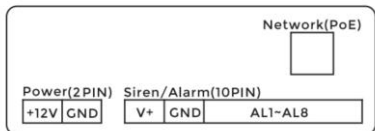

E217E

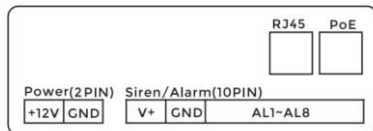

E217I

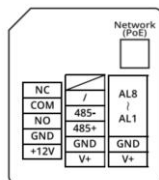

Easy-to-install Back Cover

1. Network (PoE)

Single Port:

Network (PoE) interface is for the connection with PoE switch or other network switch.

Dual Port:

1. RJ45 interface is for providing the power and network for Villa Station (special version) directly from this Indoor Monitor, so Villa Station doesn't need extra power adaptor.
2. PoE interface is for the connection with PoE switch or other network switch.

PSE shall comply with IEEE 802.3af (PoE) and its output power not less than 15.4W and its output voltage not be less than 50V.

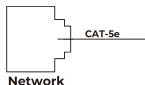

2. Power

The power interface of Indoor Monitor connects to 12V DC power.

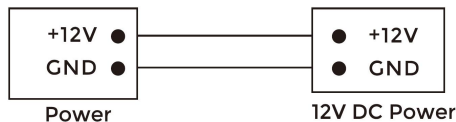

3. Relay Output

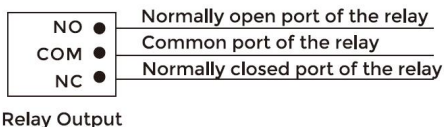

⚠ Warning!

1. When connecting to an inductive load device such as a relay or electromagnetic lock, you are recommended to use a diode 1A/400V (included in the accessories) in anti-parallel with the load device to absorb inductive load voltage peaks. The intercom will be better protected in this way.
2. The load current of the relay cannot be greater than 2A. See attached picture for more details.

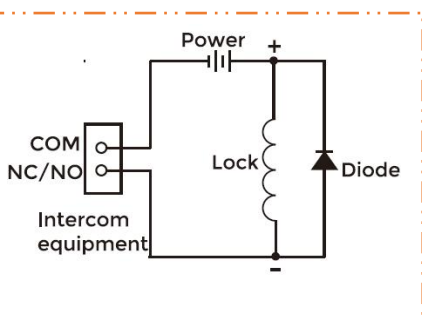

4. RS485

Enable to connect equipment with RS485 interface. RS485 interface can output 12V/100mA power supply. If RS485 equipment to be connected doesn't require the power supply, there is no need to connect to +12V.

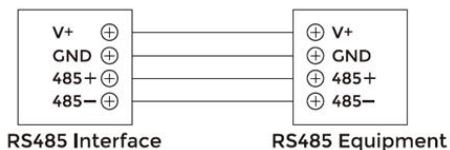

5. Siren/Alarm

Interface of alarm zones connects with normally-open or normally-closed switch.

When the alarm zone is triggered, it will output 12V/100mA power.

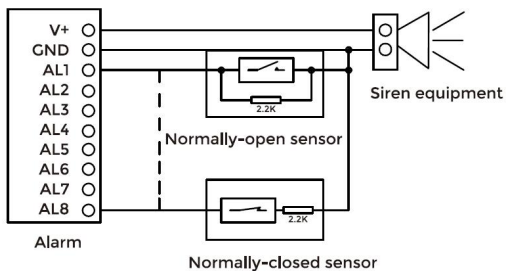

INSTALLATION

Surface Mounting-86 Mounting Box

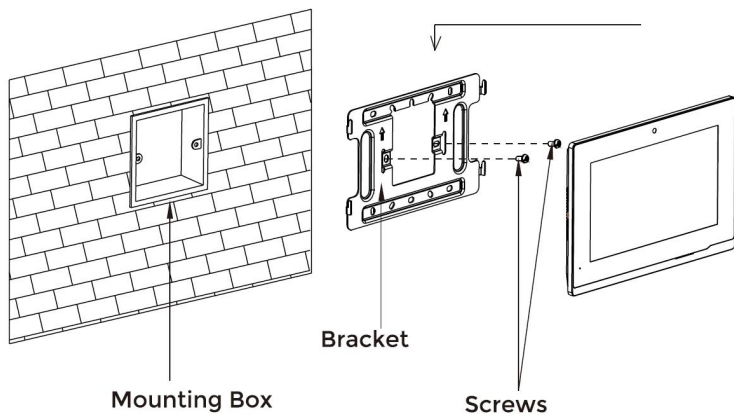

Product size: 195 × 130 × 14.5 mm

Desktop Mounting

Assemble the hooks on two sides of the bracket into the groove on the rear cover.

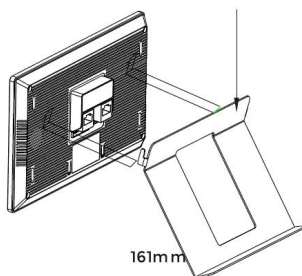

161mm

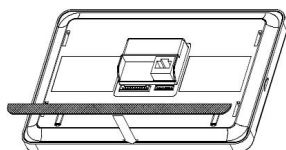

Align the edge of the silica gel pad with the lower edge of the casing, and paste the pad.

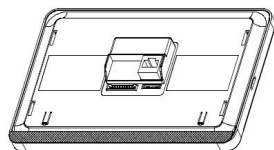
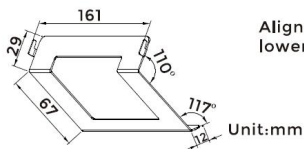

Product size: 195 × 130 × 14.5 mm

Tips:

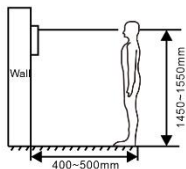

The camera should be 1450~1550mm above the ground.
The camera at this height can capture human face perfectly.

TROUBLESHOOTING

The Indoor Monitor cannot start up or power off automatically.

- Check whether it has power-failure, and power it on again

The Indoor Monitor display screen is too dim.

- Check whether the brightness and contrast settings of screen are correct.

No sound during the communication.

- Check whether the Indoor Monitor is set as mute mode, or the volume is set to the lowest.

The Indoor Monitor cannot monitor the Door Station.

- Other user is using the system, so you can use it once he/she finished the operation.

Multimedia files cannot be played normally.

- Check whether the system supports the file format. Please refer to the multimedia setting for details.

No response when clicking Indoor Monitor display screen.

- Press "Unlock" button for 5s, or slowly slide horizontally or vertically on the LCD to make touchscreen calibration. It needs to be calibrated.

Touchscreen responses slowly or cannot make calibration.

- Take down any protective paster, since it may affect identification and input for device;
- Ensure the finger is dry and clean when clicking touchscreen;
- Restart the device to clear any temporary software error.

The temperature of device is too high.

- Long-term use leads to high temperature. It's normal and will not affect the device's use life and performance.
-

SAFETY INSTRUCTION

In order to protect you and others from harm or your device from damage, please read the following information before using the device.

- Do not install the device in the following places:
- Do not install the device in high-temperature and moist environment or the area close to magnetic field, such as the electric generator, transformer or magnet.
- Do not place the device near the heating products such as electric heater or the fluid container.
- Do not place the device in the sun or near the heat source, which might cause discoloration or deformation of the device.
- Do not install the device in an unstable position to avoid the property losses or personal injury caused by the falling of device.

Guard against electric shock, fire and explosion:

- Do not use damaged power cord, plug or loose outlet.
- Do not touch the power cord with wet hand or unplug the power cord by pulling.
- Do not bend or damage the power cord.
- Do not touch the device with wet hand.
- Do not make the power supply slip or cause the impact.
- Do not use the power supply without the manufacturer's approval.
- Do not have the liquids such as water go into the device.

Clean Device Surface

- Clean the device surfaces with soft cloth dipped in some water, and then rub the surface with dry cloth.

Other Tips

- In order to prevent damage to the paint layer or the case, please do not expose the device to chemical products, such as the diluent, gasoline, alcohol, insect-resist agents, opacifying agent and insecticide.
- Do not knock on the device with hard objects.
- Do not press the screen surface. Overexertion might cause floppover or damage to the device.
- Please be careful when standing up from the area under the device.
- Do not disassemble, repair or modify the device at your own discretion.
- The arbitrary modification is not covered under warranty. When any repair required, please contact the customer service center.
- If there is abnormal sound, smell or fume in the device, please unplug the power cord immediately and contact the customer service center.
- When the device isn't used for a long time, the adaptor and memory card can be removed and placed in dry environment.
- When moving, please hand over the manual to new tenant for proper usage of the device.



**EASY & SMART
INTERCOM SOLUTIONS**