

DNAKE



User Manual

DNAKE H618

REMARK

Please follow the user manual for correct installation and testing. If there is any doubt please call our tech-supporting and customer center.

Our company applies ourselves to reformation and innovation of our products. No extra notice for any change. The illustration shown here is only for reference. If there is any difference, please take the actual product as the standard.

The product and batteries must be handled separately from household waste. When the product reaches the end of service life and needs to be discarded, please contact the local administrative department and put it in the designated collection points in order to avoid the damage to the environment and human health caused by any disposal. We encourage recycling and reusing the material resources.

CATALOG

PRODUCT FEATURE	1
TECHNICAL PARAMETER	1
PACKAGE CONTENT	2
OVERVIEW.....	3
BASIC OPERATION	4
DEVICE SETTING	13
WEB SETTING	19
SYSTEM DIAGRAM	35
DEVICE WIRING	36
INSTALLATION	38
TROUBLESHOOTING.....	40
SAFETY INSTRUCTION	41

PRODUCT FEATURE

- 1.Android 10 System
- 2.10.1-inch LCD
- 3.Powered by PoE or power adapter (DC12V/2A)
- 4.Support SIP 2.0 protocol, easy integration with other SIP devices
- 5.Compatible with 3rd party application
- 6.Support monitoring 16 IP cameras

TECHNICAL PARAMETER

System: Android 10

RAM: 2 GB

ROM: 8 GB

Front Panel: Aluminum

Power Supply: PoE (802.3af) or DC 12V/2A

Standby Power: 3 W

Rated Power: 10 W

Wi-Fi: IEEE802.11 b/g/n,@2.4GHz (Optional)

TF Card Slot: 1

Ethernet Port: 1 x RJ45, 10/100 Mbps adaptive

Resolution: 1280 x 800

Working Temperature: -10°C to +55°C

Storage Temperature: -40°C to +70°C

Working Humidity: 10% to 90% (non-condensing)

PACKAGE CONTENT

MODEL: H618



H618



Bracket



PM4x20 (2 pcs)



Diode (8 pcs)



Wires



Quick Start Guide

OVERVIEW

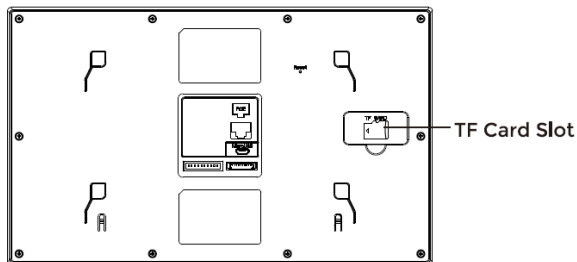
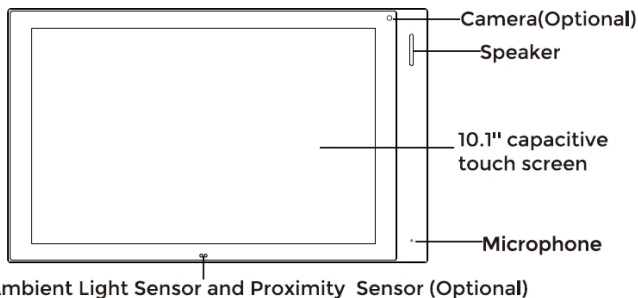

BASIC OPERATION

1. Device Interface

This smart home interface provides quick access to essential controls and information. The central panel displays the time, date, and weather, keeping users informed at a glance. The security module allows easy switching between Away, Home, Sleep, and Disarm modes, adapting to various scenarios. Users can also control curtains and lighting with simple commands, adjusting the environment to their needs. The bottom navigation offers access to room controls, ensuring seamless management of the entire home, while icons and notifications keep users updated on important alerts.



2. Customizing the Dashboard Cards

In this interface, you can personalize your dashboard by pressing and holding any card. This action allows you to edit the selected card, where you can add new cards or remove existing ones, offering flexibility in managing your smart home controls.

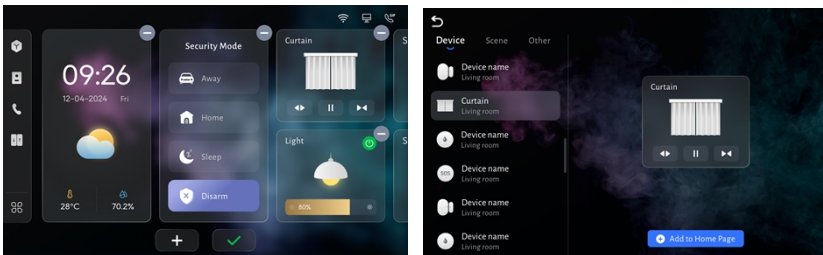

3. Smart Home

Click [Smart Home] and it will navigate to the smart home screen, showing all connected devices such as sensors and gateways. Users can add, edit, and manage devices directly from this interface.

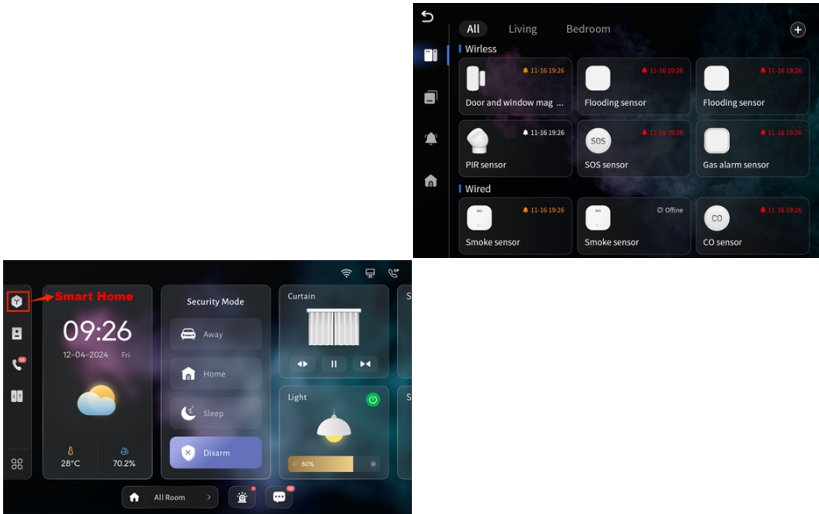

4. Doors

Click [Doors] icon on Indoor Monitor's homepage to monitor Door Station. You can unlock by clicking door icon or switch to monitor other devices by clicking arrow or the name above.

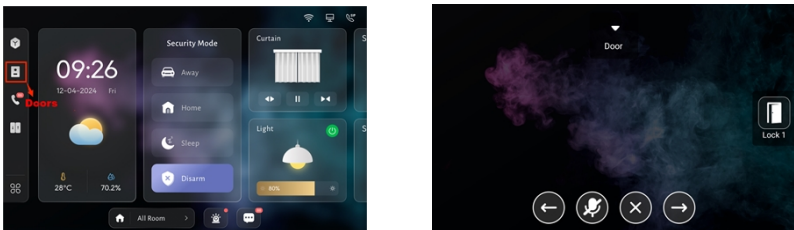

5. Call

Go to [Call] > [Dial] and enter Building number + Building + Unit number + Unit + Room number, then click [Dial] to call another Indoor Monitors (such as 1 +

Building + 1 + Unit + 1111 + Dial button). Or you can press Concierge here to call Master Station.

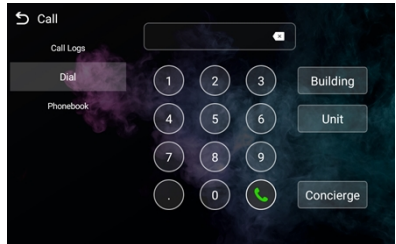

6.Elevator

Press the Elevator icon to call control elevator (DNAKE Elevator Control Module is needed).

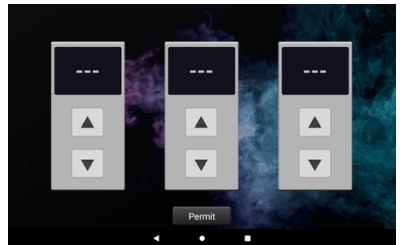

7.Application

Click [Application] to navigate to a new interface displaying multiple applications, including DND, QR Code, Phonebook, and more. Additionally, third-party applications will also appear in the [Application] interface.

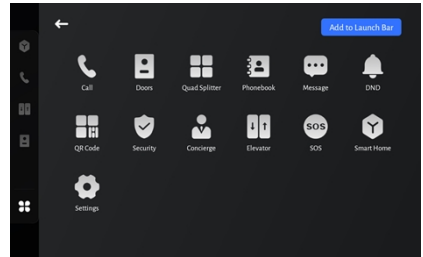

7.1 Add to Launch Bar

In this interface, you can customize the launch bar by clicking the [Add to Launch Bar] button. This feature allows you to add or remove applications from the launch bar, and the changes will be reflected on the left side, providing quick access to your frequently used apps.

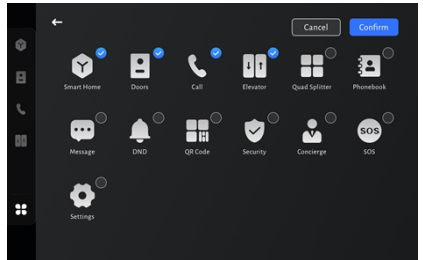
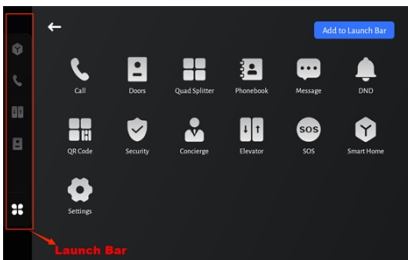

7.2 Quad Splitter

Click the [Quad Splitter] icon in [Application] to add and monitor IPC. To add an IPC, click '+', and fill the RTSP stream format:**rtsp://Username:Password@IPC IP address:8554/ch01.**(This stream is for reference ,different IPC has different formats.) Click any IPC screen to view it in full screen. Use the left or right arrows to check other page. Up to 16 IPCs can be added.

✓ **Note--How to fill the rtsp stream?**

IPC IP address:192.168.68.90

IPC username:admin

IPC password:123456

So the rtsp stream is **rtsp://admin:123456@192.168.68.90:8554/ch01**

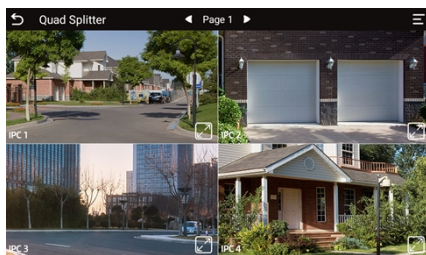

7.3 Phonebook

Click [Phonebook] in [Application] or go to [Call] >[Phonebook].Select the name on the phonebook and press dial button to call.

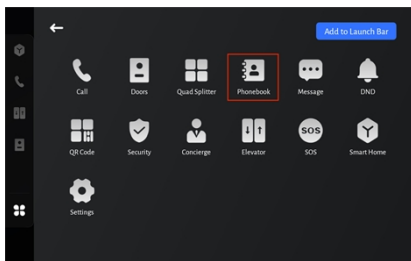

7.4 DND

Click DND icon to enable do not disturb function. No calls can call in.

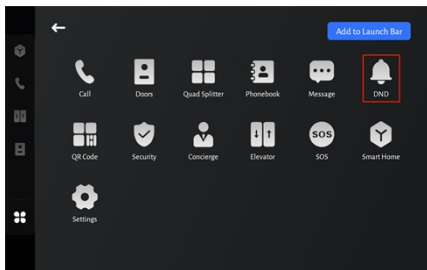

7.5 QR Code

Click QR Code and scan by DNAKE Smart Life app to add this Indoor Monitor to your phone. Only when the license is filled in Internet-connected Indoor Monitor, QR code will be available.

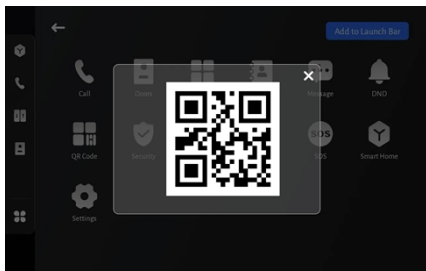
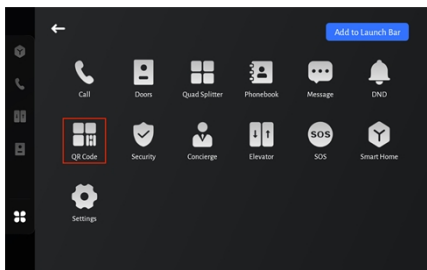

7.6 Security

Security is for sensors. The default password is 1234.

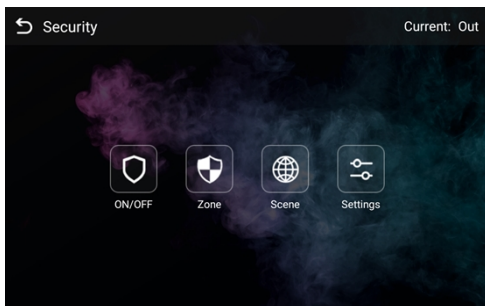

7.6.1 On/Off

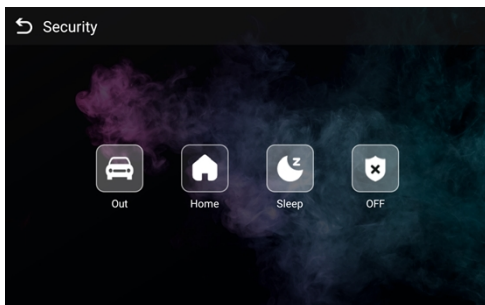

ON:	Click Out, Home, or Sleep icon to activate the scene for alarm sensors, the icon on the main interface will light up with a beep sound;
OFF:	Click OFF to disable scene;

7.6.2 Zone

NO.	Type	Mode	Delay	Sensor
1	24 Hour ▼	3C ▼	0s ▼	Smoke ▼
2	24 Hour ▼	3C ▼	0s ▼	Smoke ▼
3	24 Hour ▼	3C ▼	0s ▼	Smoke ▼
4	24 Hour ▼	3C ▼	0s ▼	Smoke ▼

Type:	<ul style="list-style-type: none"> • Normal: When users enable an alarm scene on the On/Off page, Normal type alarm zone will be activated after activation time. <ul style="list-style-type: none"> ○ 100 seconds is the default activation time, it means the alarm will be activated after 100 seconds. ○ After 100s, once sensor is triggered, Indoor Monitor will send this alarm to Master Station. ○ But sometimes users don't want to send the alarm to Master Station (maybe alarm by mistake), users can set the Delay time, so they can cancel the alarm in the Indoor Monitor during this Delay time (PIR, Door, Window); • Emergency: once Panic button is triggered, Indoor Monitor will not initiate an alarm and only Master Station will receive alarms secretly; 24 hours standby even if the security is off (Panic, Pull Cord); 24 Hour: Indoor Monitor will initiate an alarm and Master Station will also receive alarms. 24 hours standby even if the security is off (Smoke, Gas, Flood);
Mode:	<ul style="list-style-type: none"> • 3C: for the sensor with 2.2KΩ resistance; Regardless of the connection to NC or NO, the alarm can be triggered normally; • NO: normally open; • NC: normally closed;

	BELL: in BELL mode, Master Station will not receive any alarm. Indoor Monitor is regarded as a doorbell receiver;
Delay:	Once sensor is triggered, Indoor Monitor will send this alarm to Master Station, but users can terminate the alarm sending to Master Station during the delayed time set here. Delay setting is only effective for Normal type (0s, 5s, 15s, 20s, 25s, 40s, 60s);
Sensor:	Sensor types (Smoke, Gas, PIR, Door, Window, Panic, Flood, Pull Cord);

7.6.3 Scene

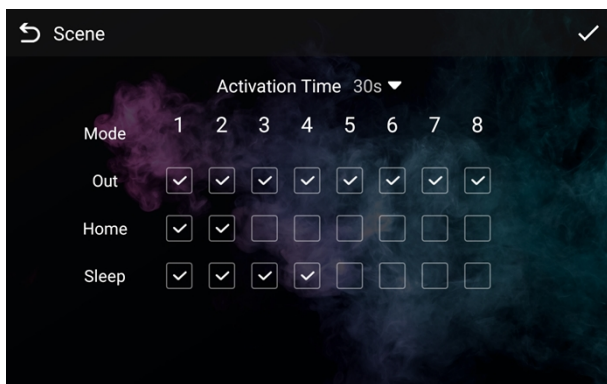

Activation Time:	Only after activation time, will scene be activated. Activation time is only effective for Normal type (NONE, 30s, 40s, 60s, 100s, and 300s);
Mode:	Tick to link sensors to Out, Home, or Sleep scene;

7.6.4 Settings

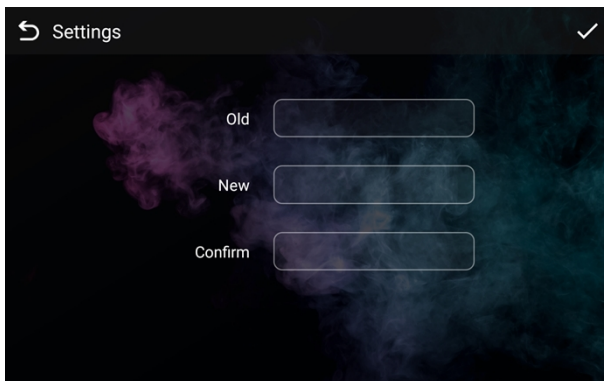

Old:	Current security password of the Device (Default 123456);
New:	New security password of the Device;
Confirm:	Confirm security password of the Device;

7.7 Concierge

Press the Concierge icon to call Master Station one by one.

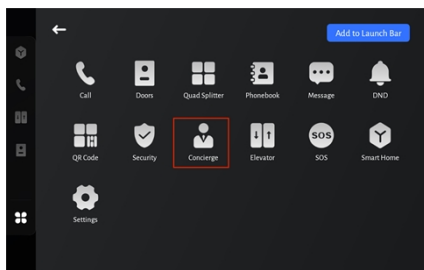
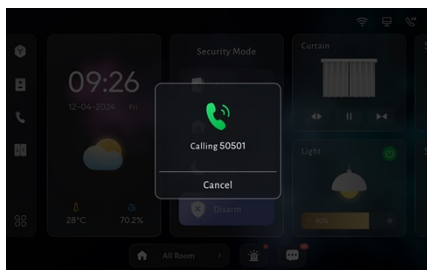

7.8 SOS

Users can press SOS icon on the 2nd homepage to send SOS to Master Station. Users can set the trigger time length on the webpage. If the time is set to 3s, users need to press the SOS icon for 3s to send out SOS in case of a wrong operation alarm.

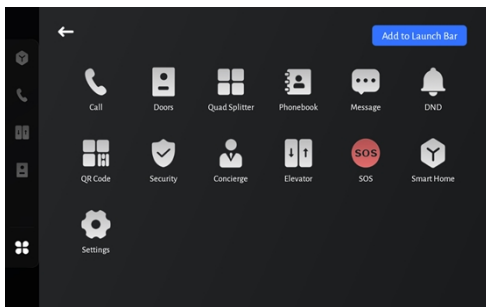

8. Alarm Center

Click [Alarm Center], and all smart home device alarms, such as those from door sensors and motion sensors, will be displayed on the screen.

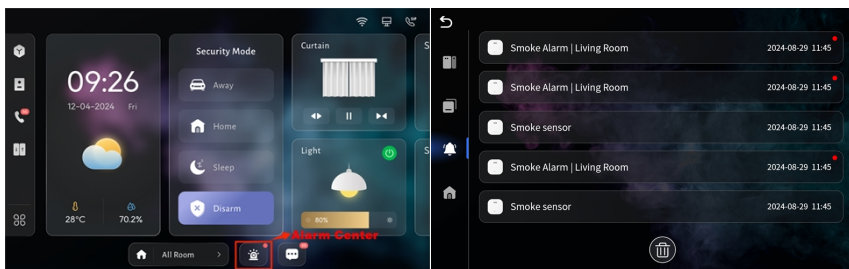

9. Message

Indoor Monitor can only receive the message sent by the CMS or Master Station. Up to 64 records can be received in SMS.

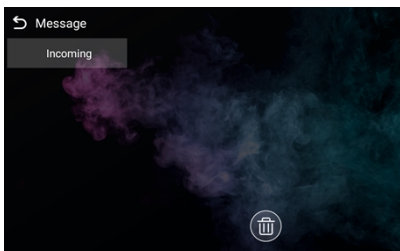

SMART HOME

1. Create Home

When the device is first started, you will be prompted to create a home. This gives you the opportunity to establish a centralized control hub for all your smart devices. Select the region your located, then click <Yes>. Finally the device will generate the invitation code.

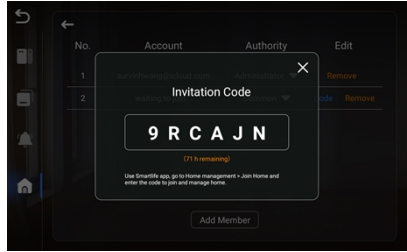
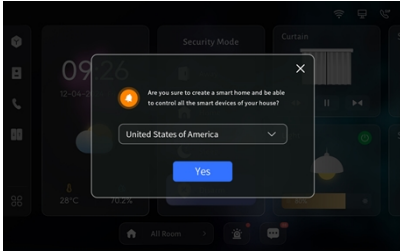

Once the home is created successfully, a code is generated. You can then use the Smartlife app to join and manage the home.

✓ Step1: Click [Home Management]

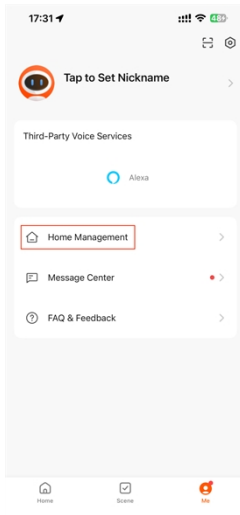

✓ **Step2:Click [Join Home]**

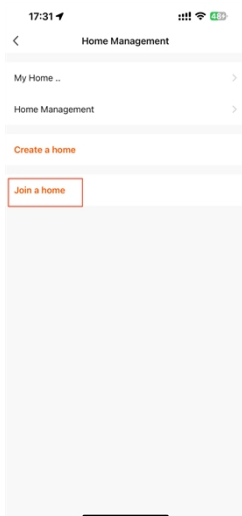

✓ **Step2:Enter the invitation code.**

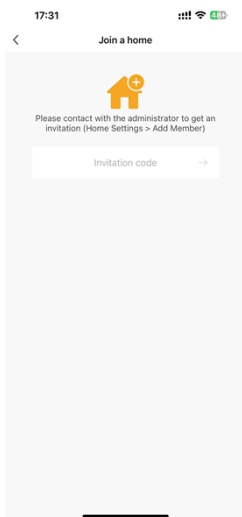

2.Sensor







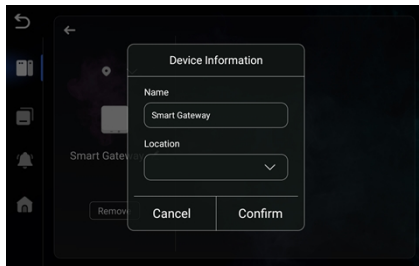
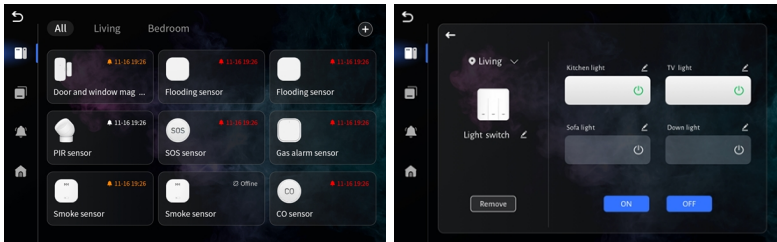

This interface displays all connected smart home devices, organized by rooms such as 'Living' and 'Bedroom.' It shows the status of each device, including sensors and alarms. Users can view alerts and access details for each device. The '+' button allows adding new devices.



2.1 Device List

Users can view the devices that have been added to the home and edit the device name and location by clicking on the device icon.



	Smart Hub:	The Smart Hub supports Wi-Fi, Zigbee 3.0 and Bluetooth Sig Mesh multi-protocol communication. This allows it to seamlessly connect with various wireless accessories through the DNAKE Smart Life App.
	Door and Window Sensor:	The Door and Window Sensor are able to detect the opening and closing of doors, windows, cabinet doors, drawers, and other objects promptly.
	Water Leak Sensor:	The water leak sensor can be conveniently placed in sensitive areas. Whenever water immersion is detected, the sensor promptly sends an alarm signal to the smart hub.
	Smart Button:	The Smart Button serves a dual purpose, it functions as a portable emergency push switch panic button for alarms and also a scene button for home automation.
	Gas Sensor:	The Gas Sensor functions to detect and prevent natural gas leakage. When the gas density in the air surpasses the alarm level, the sensor promptly triggers an alarm.
	Smoke Sensor:	The Smoke Sensor capable of detecting the presence of smoke in real-time and provide timely alerts to keep family safety.
	Motion Sensor:	The Motion Sensor are able to detect motion within a wide range and trigger alarm signal, guarding your home 24/7.
	Temperature and Humidity Sensor:	The Temperature and Humidity Sensor is equipped with a high-precision temperature and humidity sensor inside, which can provide high-precision data. The sensor also includes a user-friendly display screen for easy access to the recorded information.

2.2 Checking the device status

This screen allows users to check the device status. For example, in the case of a smoke sensor, users can view recent alarms such as smoke alerts or low battery notifications. Users can also rename the device and assign it to different rooms for easier management.



2.3 Add device

After add Gateway to Smart Life APP, you can add sensors by searching devices. Click “+” to add device. The device will start looking for smart home accessory. Once found, it will display that the search is completed and it can t be added to your home.



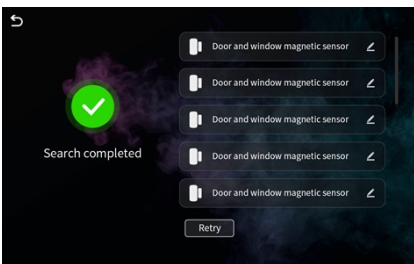
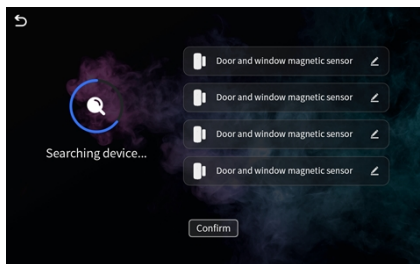

3.Scene

3.1 Security Mode

In the security mode, there are three modes available: Out Mode, Home Mode, and Sleep Mode. When you enable a mode such as Out Mode, you can set an activation time. For instance, setting it to 30 seconds means that after 30 seconds, the system will start to arm (go into a state of being on guard).

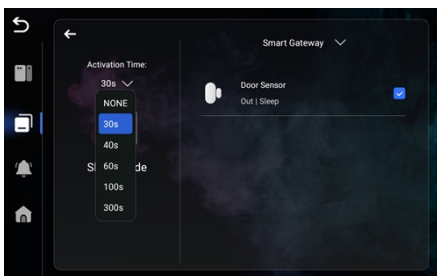
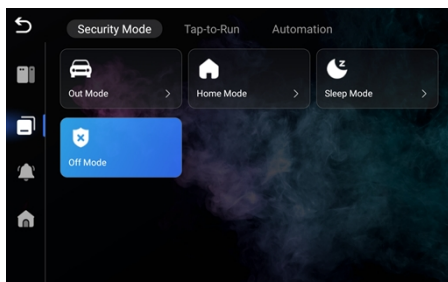

3.2 Tap-to-Run

The "tap-to-run" function allows residents to create custom scenes, such as a meeting scene or a sleep scene, etc. Once activated, all connected sensors and smart home devices will automatically adjust based on the preset configuration. For example, in a sleep scene, all the lights will turn off, and the curtains will close, creating the desired environment with a single tap.

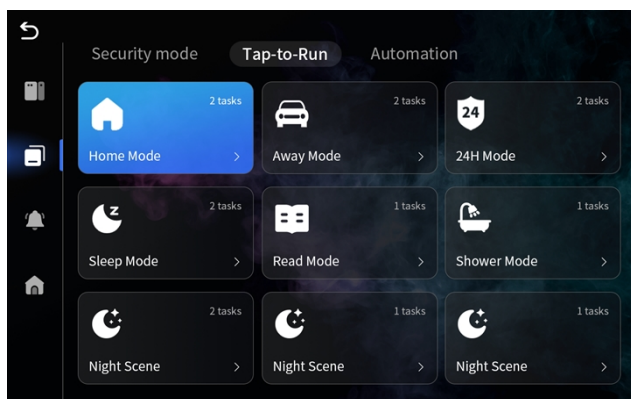

3.3 Automation

The "automation" function allows residents to set tasks that trigger actions automatically based on specific conditions. For instance, you can create an automation that turns off all the lights at 11 p.m. each day. When the set time arrives, the system will automatically carry out the task, turning off all the lights as specified.

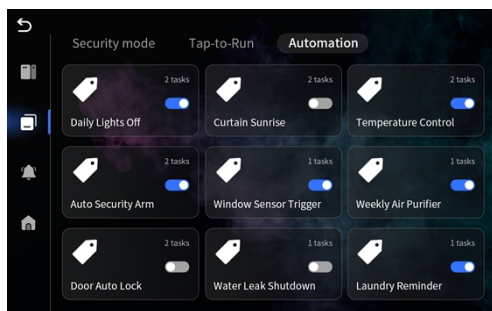

4. Alarm center

The Alarm Center collects and displays all alarms triggered by connected smart home devices. Alarms from sensors such as door sensors, motion sensors, or smoke detectors are reported to the Alarm Center for easy monitoring and management.

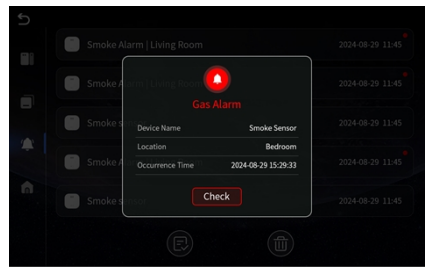

5. Home Management

The Home Management allows users to edit the home name. Additionally, users can edit the home name, manage the number of home and set someone as an administrator.

5.1 Member management

Click <Home Member> to home member management, and the password is “1234”.

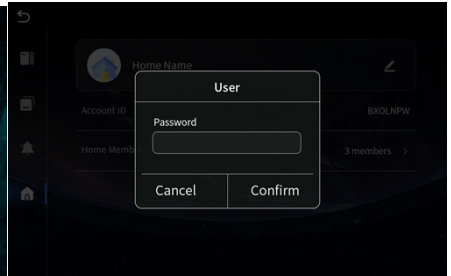
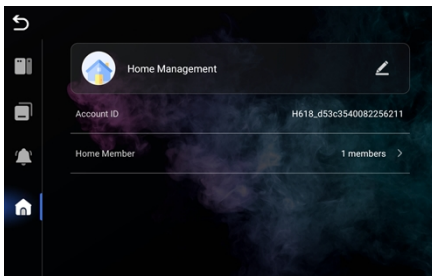

An administrator can invite to four family members for home management. Clicks on "Add Member", an invitation code is generated. Family members can then use the Smartlife app and this code to join the home management.

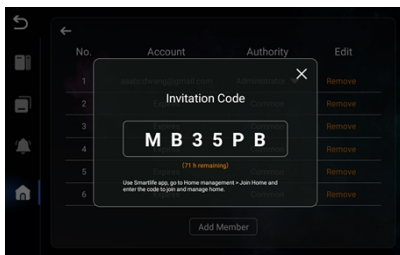
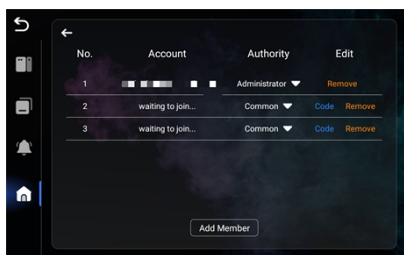

DEVICE SETTING

Connect Indoor Monitor and other devices to a network switch in the same LAN.
Go to Settings to configure the device.



1. Display

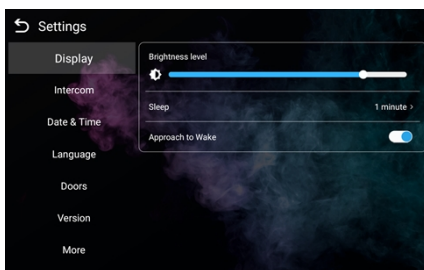

Brightness level: | Screen brightness adjustment;

Sleep:	Screen sleep time (15s, 30s, 1min, 2mins, 5mins, 20mins, 30mins);
Approach to Wake:	Get close to device to wake screen;

2. Intercom

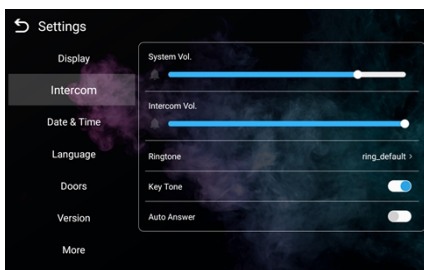

System Vol:	Volume of System can be set from 1 to 6. Volume 6 is the maximum volume (Key tone);
Intercom Vol:	Volume of Intercom can be set from 1 to 6. Volume 6 is the maximum volume (Call volume);
Ringtone:	The ringing sound (Ringtone 01-04);
Key Tone:	The keytone (Enable or disable);
Auto Answer:	Pick up automatically when receiving a call;

3. Date & Time

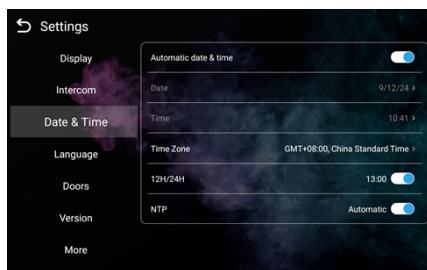

Automatic date & time:	Enable to synchronize computer time;
Time Zone:	A region that observes a uniform standard time;
12H/24H:	Select 12H or 24H format to display on the device;
NTP:	Network Time Protocol (NTP) is a protocol used to synchronize computer time;

4. Language

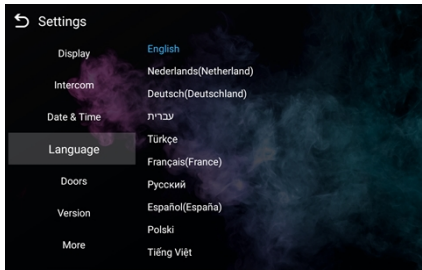

Language: 16 languages supported (简体中文, English, 繁體中文, עברית, Deutsch, Español, Türk, Tiếng Việt, Nederlands, Português, Polski, Русский, عربي, Français, Italiano, slovenský);

5. Doors

You need to click search icon to add Door Stations to Indoor Monitor and click tick to save before monitoring. Click funnel icon to pin the selected device to the top. Click pen icon to edit devices.

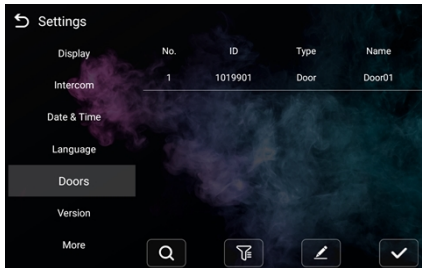

6. Version

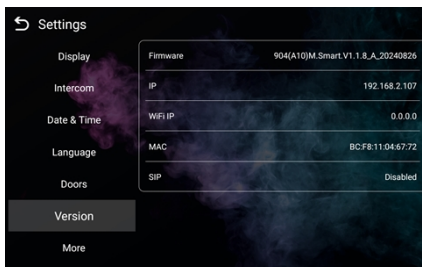

Firmware:	Firmware version of the device;
IP:	Current IP address of the device;
Wi-Fi IP:	Current Wi-Fi IP address of the device;
MAC:	MAC address of the device;
SIP:	Status of SIP registration of the device;
Reboot:	Reboot the device;

7. More > Ethernet

The device network can be set to either DHCP or a static IP address. CMS parameters should be configured here when you try to register this device to CMS.

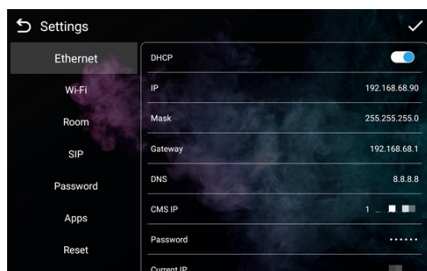

DHCP:	Enable DHCP (Dynamic Host Configuration Protocol) to dynamically distributing network configuration parameters;
IP:	Configure Static IP address to manually distributing network configuration parameters;
Mask:	Subnet mask;
Gateway:	A component that is part of two networks, which use different protocols;
DNS:	Domain Name Server of the device;
CMS IP:	Server address of CMS;
Password:	Password you set for this device's CMS registration;
Current IP:	Current IP address of the device;

8. More > Wi-Fi

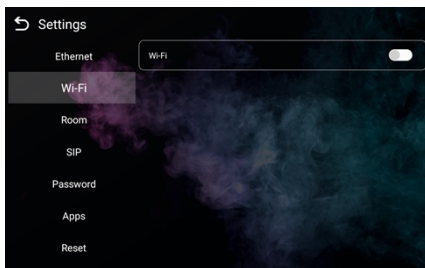

Wi-Fi:	Enable to connect to Wi-Fi;
--------	-----------------------------

9. More > Room

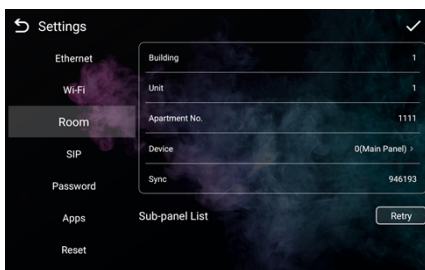

Building:	Number of the building (Range: 1-999);
Unit:	Number of the unit (Range: 0-99);
Apartment No.:	Number of the apartment (Range: 0-9899);
Device:	Number of the device (Range: 0-9);
Sync:	A number used to synchronize to other Indoor Monitors;

9.1 Sub-Panel

In this interface, the sub-panel (also called the secondary panel) is bound to the main panel, allowing the sub-panel to control and manage the devices that are connected to the main panel. The binding process ensures that both the main panel and sub-panels can interact with the same set of devices, such as smart home systems, ensuring seamless control from multiple locations.

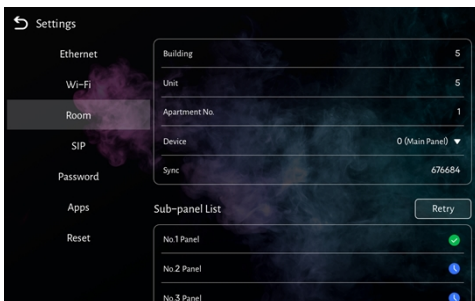

10. More > SIP

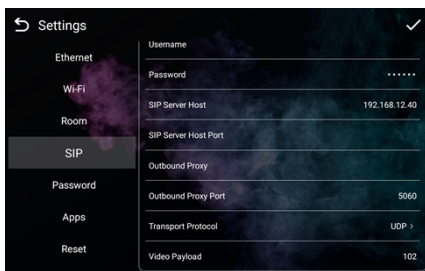
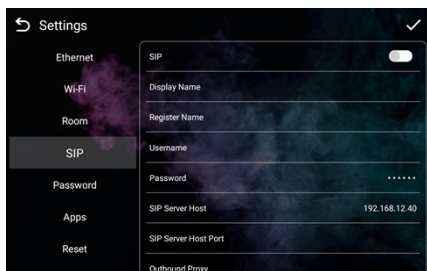

SIP:	Enable to use SIP;
Display Name:	Display name of SIP account;
Register Name:	Register Name of SIP account;
Username:	Username of SIP account;
Password:	Password of SIP account;
SIP Server Host:	Directly fill in SIP server's address e.g., 192.168.68.90; The default port is 5060;
SIP Server Host Port:	The default port is 5060;
Outbound Proxy:	Outbound Proxy server; the default port is 5060;
Outbound Proxy Port:	The default port is 5060;
Transport Protocol:	Transport Protocol (UDP, TCP, TLS);
Video Payload:	Video payload range is 96-127;

11. More > Password

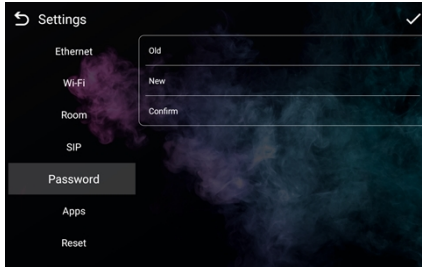

Old Password:	Current administrator password of the Device (Default 123456);
New Password:	New administrator password of the Device;
Confirm Password:	Confirm administrator password of the Device;

12. More > Apps

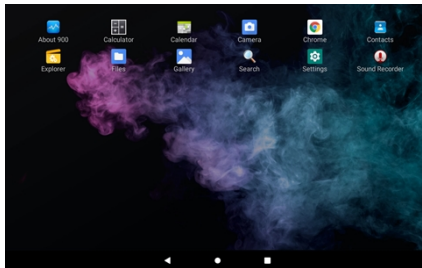

Apps:	3rd party apps can be managed here;
-------	-------------------------------------

13. More > Reset

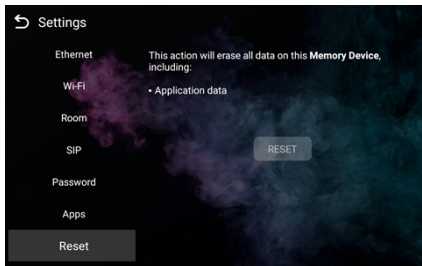

Reset:	Reset to factory settings;
--------	----------------------------

WEB SETTING

Connect Indoor Monitor and PC to a network switch in the same LAN. You can enter the IP address of Indoor Monitor in the web browser search bar and log in with the default account (admin) and password (123456). This is where you can configure the device.

To get the IP address, you can search by DNAKE Remote Upgrade Tool installed in the same LAN with the devices.

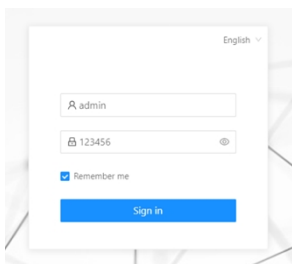

1. General

1.1.General > Information

When you first log in to the web interface, you can find basic information displayed in this dashboard.

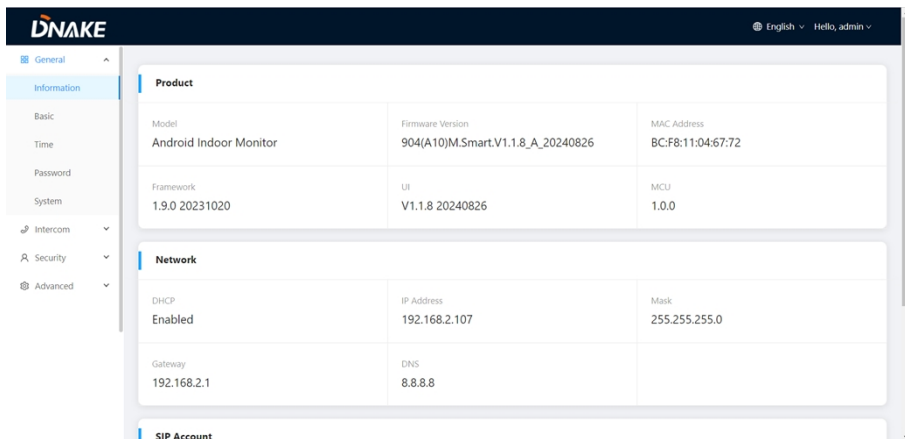

Product		
Model	Firmware Version	MAC Address
Android Indoor Monitor	904(A10)M.Smart.V1.1.8_A_20240826	BC:F8:11:04:67:72
Framework	UI	MCU
1.9.0 20231020	V1.1.8 20240826	1.0.0

Network		
DHCP	IP Address	Mask
Enabled	192.168.2.107	255.255.255.0
Gateway	DNS	
192.168.2.1	8.8.8.8	

SIP Account

Model:	Model of the device;
Firmware Version:	Firmware version of the device;
MAC Address:	MAC address of the device;
Framework:	Framework of the device;
UI:	UI of the device;
DHCP:	Status of DHCP;
IP Address:	Current IP address of the device;
Mask:	Subnet mask of the device;
Gateway:	Gateway of the device;
DNS:	Domain Name Server of the device;
Account:	SIP account of the device;
Status:	Status of SIP registration of the device;
CMS IP:	IP address of CMS;
Status:	Status of CMS registration;

1.2.General > Basic

Some basic settings of the device can be configured in this column.

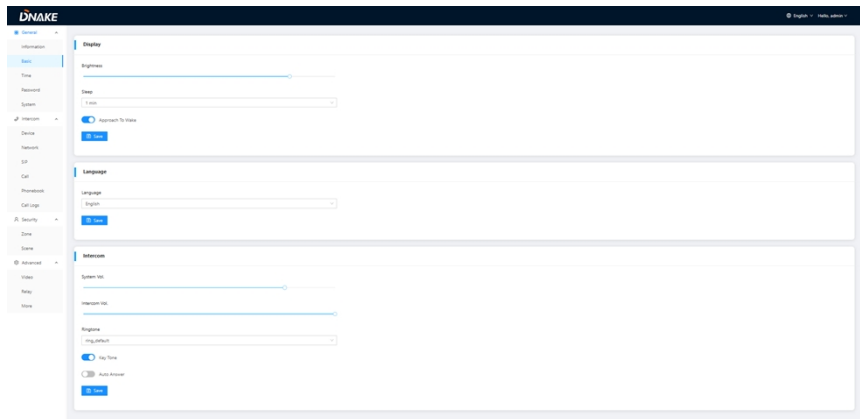

Brightness:	The brightness of the screen;
Sleep:	Screen off timeout (15s, 30s, 1min, 2mins, 5mins , 10mins, 30mins);
Approach to Wake:	Get close to device to wake screen;
Language:	16 languages supported (简体中文, English, 繁體中文, עברית, Deutsch, Español, Türk, Tiếng Việt, Nederlands, Português, Polski, Русский, عربي, Français, Italiano, slovenský);
System Vol:	Volume of System can be set from 1 to 6. Volume 6 is the maximum volume (Key tone);
Intercom Vol:	Volume of Intercom can be set from 1 to 6. Volume 6 is the maximum volume (Call volume);
Ringtone:	The ringing sound (Ringtone 01-04);
Key Tone:	The keytone (Enable or disable);
Auto Answer:	Pick up the phone automatically when receiving a call;

1.3.General > Time

Time of the device can be configured. Daylight Saving Time is also supported.

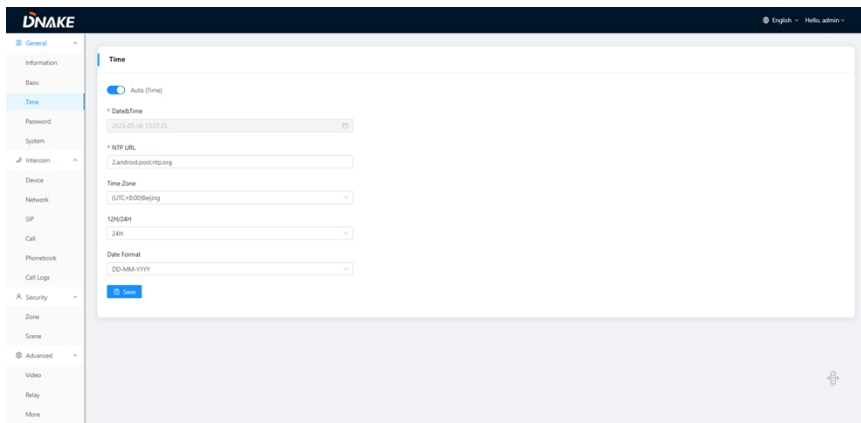

Auto (Time):	Enable to synchronize computer time;
Date&Time:	Date and time can be set manually;
NTP URL:	Network Time Protocol (NTP) is a protocol used to synchronize NTP time;
Time Zone:	A region that observes a uniform standard time;
12H/24H:	Select 12H or 24H format to display on the device;

Date Format:	3 time formats supported (YYYY-MM-DD, DD-MM-YYYY, MM-DD-YYYY);
--------------	--

1.4.General > Password

The System password is for the administrator to log in settings on the device while the Web password is for the administrator to log in settings on the web. The default password for both of them is 123456. User for Indoor Monitor is the security password whose default password is 1234.

System Old Password:	Current administrator password of the Device (Default 123456);
System New Password:	New administrator password of the Device;
System Confirm Password:	Confirm administrator password of the Device;
User Old Password:	Current security password of the Device (Default 1234);
User New Password:	New security password of the Device;
User Confirm Password:	Confirm security password of the Device;
Web Old Password:	Current administrator password of the web (Default 123456);
Web New Password:	New administrator password of the web;
Web Confirm Password:	Confirm administrator password of the web;

1.5.General > System

The system column is designed for data backup and restore, firmware upgrade, factory default, device reboot, packet capture, logs capture, and obtaining UI screenshots.

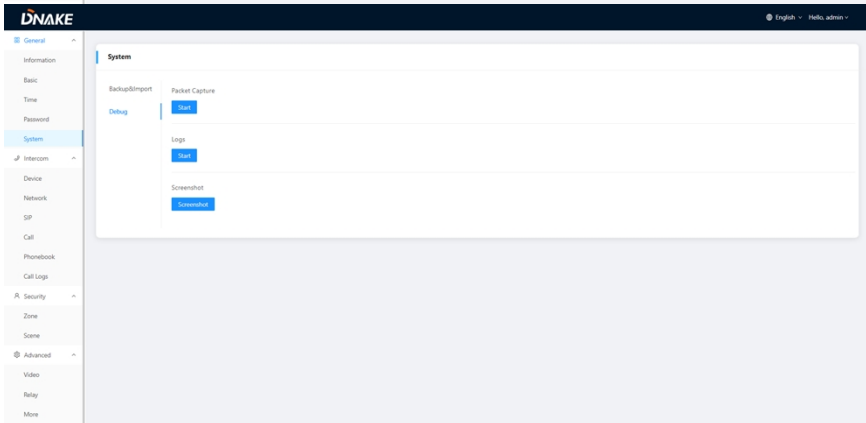
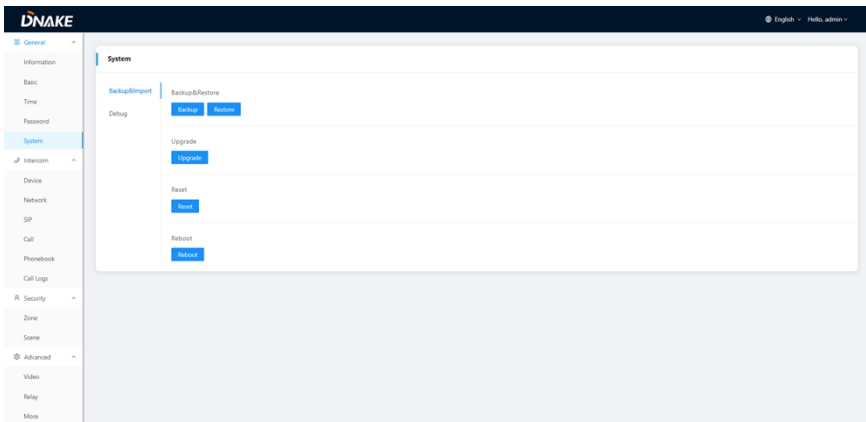

Backup&Restore:	Backup all setting and restore settings;
Upgrade:	Upgrade equipment;
Reset:	Reset to factory settings;
Reboot:	Reboot the device;
Packet Capture:	Capturing packets can help developers reproduce positioning problems;
Logs:	Device logs;
Screenshot:	Screenshot device interface;

2. Intercom

2.1. Intercom > Device

Numbers here are basic settings for making a call to Indoor Monitor. For Door Station, the building and unit number should be the same as those in Indoor Monitor.

For Villa Station with one button, the building, unit, and room number should be the same as those in Indoor Monitor.

When users want to use more than 1 Indoor Monitors, keep Building, Unit, Apartment No., Sync the same as other Indoor Monitors, and Device number should be different. The Device number can be from 0 to 9. But you must have one Indoor Monitor's Device number is 0 and keep it online because 0 here stands for the main one.

The screenshot shows the 'Device' configuration page in the D-NAKE interface. The left sidebar is expanded to show the 'Device' option. The main content area contains a form with the following fields and values:

- Building: 1
- Unit: 1
- Room: 1111
- Device No.: 0
- Sync: 421917

A blue 'Save' button is located at the bottom of the form.

Building:	Number of the building (Range: 1-999);
Unit:	Number of the unit (Range: 0-99);
Room:	Number of the apartment (Range: 0-9899);
Device No:	Number of the device (Range: 0-9);
Sync:	A number used to synchronize to other Indoor Monitors;

2.2. Intercom > Network

The device network can be set to either DHCP or a static IP address. CMS parameters should be configured here when you try to register this device to CMS.

The screenshot shows the Dnake web interface for configuring a device's network settings. The 'Network' section is active, showing a 'DHCP' toggle that is turned on. Below this are input fields for IP Address (192.168.88.88), Mask (255.255.255.0), and Gateway (192.168.88.1). The 'Register To CMS' section is also active, showing a 'CMS' toggle that is turned on, and input fields for CMS IP (192.168.12.40) and Password (*****). A 'Save' button is visible at the bottom of each section.

DHCP:	Enable DHCP (Dynamic Host Configuration Protocol) to dynamically distribute network configuration parameters;
IP Address:	Configure Static IP address to manually distribute network configuration parameters;
Mask:	Subnet mask;
Gateway:	A component that is part of two networks, which use different protocols;
DNS:	Domain Name Server of the device;
CMS:	Enable to use CMS software to manage devices;
CMS IP:	Server address of CMS;
Password:	Password you set for this device's CMS registration;

2.3. Intercom > SIP

The SIP column concerns SIP registration, Display Name, Register Name, Username, Password, SIP Server Host, Outbound Proxy, Transport Protocol, Video Payload, etc.

SIP:	Enable to use SIP;
Display Name:	Display name of SIP account;
Register Name:	Register Name of SIP account;
Username:	Username of SIP account;
Password:	Password of SIP account;
SIP Server Host:	Directly fill in SIP server's address e.g., 192.168.68.90; The default port is 5060;
Outbound Proxy:	Outbound Proxy server; the default port is 5060;
Transport Protocol:	Transport Protocol (UDP, TCP, TLS);
Ring Code:	Ring code. Without SDP or with (180 or 183);
Video Payload:	Video payload range is 96-127;

2.4. Intercom > Call

Ring group is for setting up SIP calls or call mode. Concierge button, extension of other Indoor Monitors, the length of the call, and ring time can also be configured here.

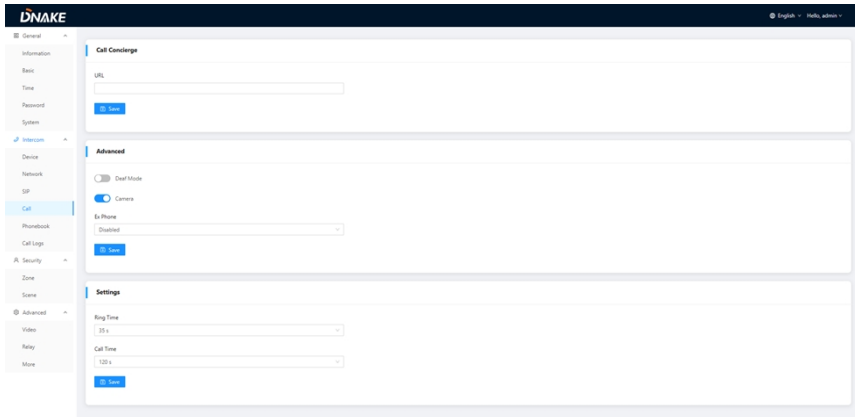

Call Concierge URL:	<p>Fill in the call destination for concierge button or the single button on the device;</p> <ul style="list-style-type: none"> ● IP call: Fill in sip:IP address, e.g., sip:192.168.68.90; ● SIP call: Fill in sip:sip account@SIP server address:port, e.g., sip:101@192.168.68.90:5060;
Deaf Mode:	The lamp connecting to Indoor Monitor will be turned on when receiving a call;
Camera:	Enable to allow other Indoor Monitors or Master Stations to see your image when your Indoor Monitor has a built-in camera;
Ex Phone:	Extend to more Indoor Monitors by filling in sip:IP address (6 Max) such as sip:192.168.68.90 (6 Max);
Ring Time:	The ring will be ended automatically after a period of time (10s, 20s, 35s, 45s, 60s, 90s, 120s)
Call Time:	The call will be ended automatically after a period of time (120s, 300s, 600s, 1200s, 1800s);

2.5. Intercom > Phonebook

All contacts on Indoor Monitor can be edited here.

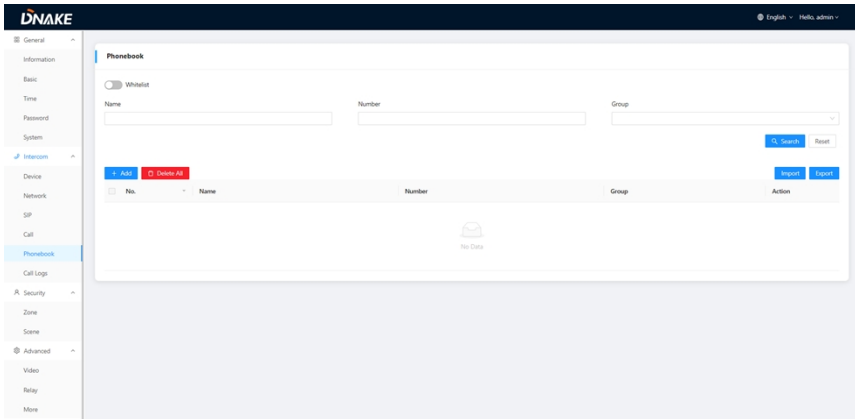

Whitelist:	Enable whitelist to block other calls outside of the whitelist. For example, Ana is in the whitelist but Nyree isn't in it. Ana can call in while Nyree can't;
Search:	Fill in text inputs to search;
Reset:	Click reset to clear words in text inputs;
Add:	Click to add more contacts;
Delete All:	Delete all data on the chart;
Import:	Import all data to the chart;
Export:	Export all data on the chart;

2.6. Intercom > Call Logs

All call logs can be checked here.

Search:	Fill in text inputs to search;
Reset:	Click reset to clear words in text inputs;
Delete All:	Delete all data on the chart;
Export:	Export all data on the chart;

3. Security

3.1. Security > Zone

Zone column is the setup page for security sensors.

Type:	<ul style="list-style-type: none"> • Normal: When users enable an alarm scene on the On/Off page, Normal type alarm zone will be activated after activation time. <ul style="list-style-type: none"> ○ 100 seconds is the default activation time, it means the alarm will be activated after 100 seconds. ○ After 100s, once sensor is triggered, Indoor Monitor will send this alarm to Master Station. ○ But sometimes users don't want to send the alarm to Master Station (maybe alarm by mistake), users can set the Delay time, so they can cancel the alarm in the Indoor Monitor during this Delay time (PIR, Door, Window); • Emergency: once Panic button is triggered, Indoor Monitor will not initiate an alarm and only Master Station will receive alarms secretly; 24 hours standby even if the security is off (Panic, Pull Cord); 24 Hour: Indoor Monitor will initiate an alarm and Master Station will also receive alarms. 24 hours standby even if the security is off (Smoke, Gas, Flood);
Mode:	<ul style="list-style-type: none"> • 3C: for the sensor with 2.2KΩ resistance; Regardless of the connection to NC or NO, the alarm can be triggered normally; • NO: normally open; • NC: normally closed; BELL: in BELL mode, Master Station will not receive any alarm. Indoor Monitor is regarded as a doorbell receiver;
Delay:	Once sensor is triggered, Indoor Monitor will send this alarm to Master Station, but users can terminate the alarm sending to Master Station during the delayed time set here. Delay setting is only effective for Normal type (0s, 5s, 15s, 20s, 25s, 40s, 60s);
Sensor:	Sensor types (Smoke, Gas, PIR, Door, Window, Panic, Flood, Pull Cord);

3.2.Security > Scene

Scene column is for security sensors' trigger conditions.

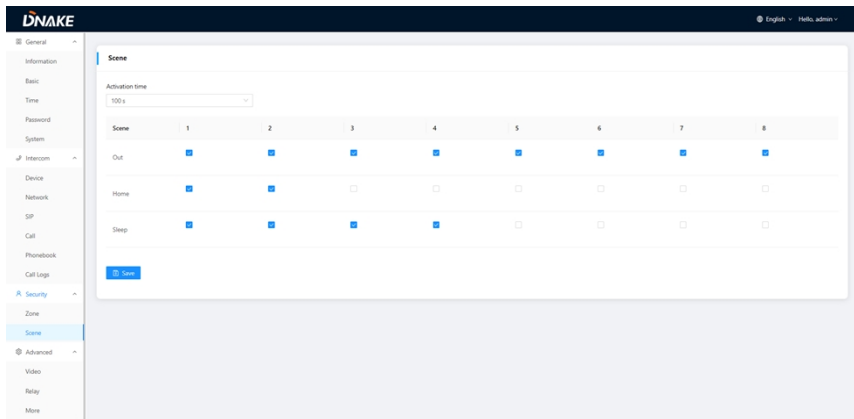

Activation Time:	Only after activation time, will scene be activated. Activation time is only effective for Normal type (NONE, 30s, 40s, 60s, 100s, and 300s);
Mode:	Tick to link sensors to Out, Home, or Sleep scene;

4. Advanced

4.1. Advanced > Video

Video here is for users to show their IPC image for the one they are talking with.

For example, users receive calls from Master Station or Indoor Monitor. They can see the IPC image because users filled in IPC's RTSP Feed here.

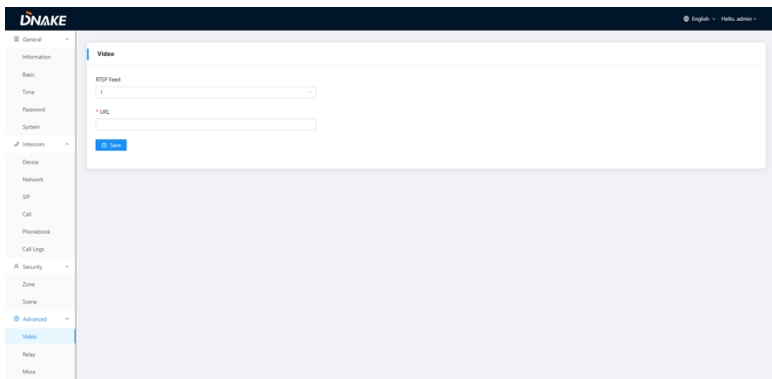

RTSP Feed: Fill in the IP camera stream URL here.

4.2.Advanced > Relay

Relay column is for Local Relay and Door Relay.

Local Relay Type:	Type of local relay (Open Door is for lock/Chime Bell is for doorbell);
Local Relay Delay:	The length of unlock delay time (1-9s);
Unlock Button 1-3:	Enable or disable relays for unlock buttons;
Name:	Customize name for unlock button;
Type:	Type 1-3: 3 types of unlock way are optional (Local Relay/DTMF/HTTP) HTTP——the format is <code>http://192.168.3.119/cgi-bin/webapi.cgi?api=unlock&index=2&username=admin&password=E10ADC3949BA59ABBE56E057F20F883E</code> ; Note: <ul style="list-style-type: none"> • "192.168.3.119" is the IP address of Door Station; • The number "2" after "index=" is the number for relay. (Relay 1 is 0; relay 2 is 1; relay 3 is 2); • "admin" here should be changed to your admin account; • "Password" is Password of admin; • "E10ADC3949BA59ABBE56E057F20F883E" here is MD5 (Message-Digest Algorithm) encrypted. Users need to use account password to encrypt and change it. DTMF——Dual-tone multi-frequency signaling, Relay1: #, Relay2:0, relay3: *;

4.3. Advanced > More

More column is for SOS and Wallpaper.

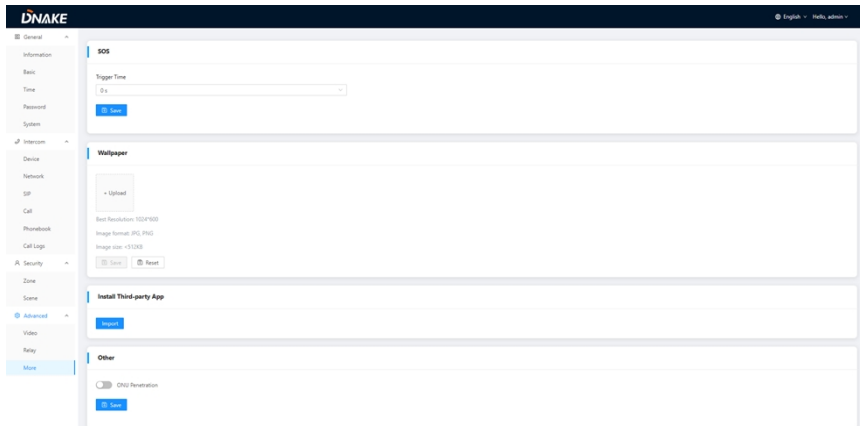

SOS:	Trigger Time can be set to 0s and 3s. If the time is set to 3s, users need to press the SOS icon for 3s to send out SOS in case of a wrong operation alarm.;
Wallpaper:	Upload a picture to apply it to the device UI. Please make sure the picture's resolution is the same as the device's and the size of the picture should be lower than 512KB. The format of Picture should be JPG or PNG;
Install Third-party App:	Install 3rd-party apps on Indoor Monitor. Click Import to select apk. file and install.
ONU Penetration:	Please enable when using optical cable but not network cable in the building;

5. IPC

You can enter the IP address of Indoor Monitor in the web browser search bar and log in with the default account (user) and password (1234). This is where you can add IPC.

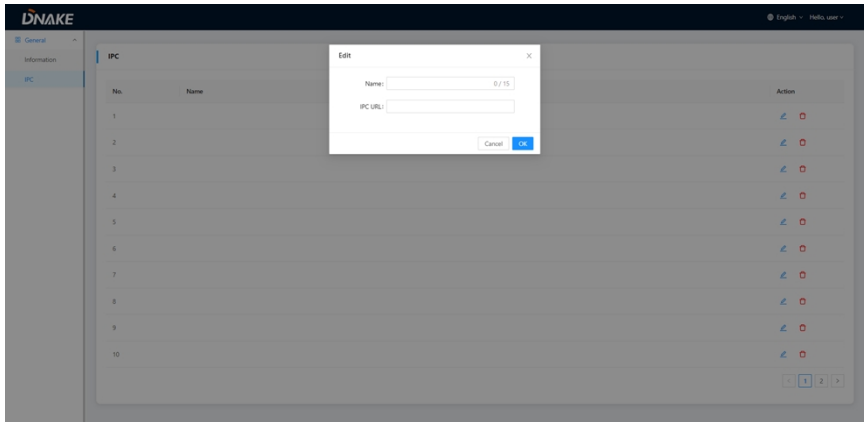
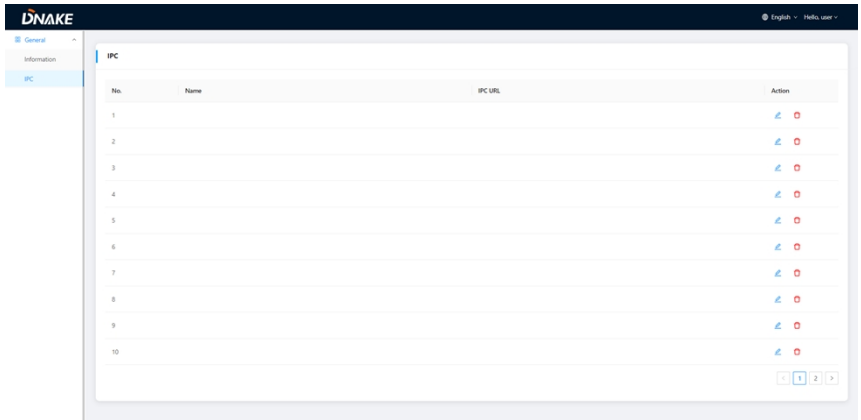

Name:	Customize name of IPC;
IPC URL:	Fill in IPC's RTSP stream;

SYSTEM DIAGRAM

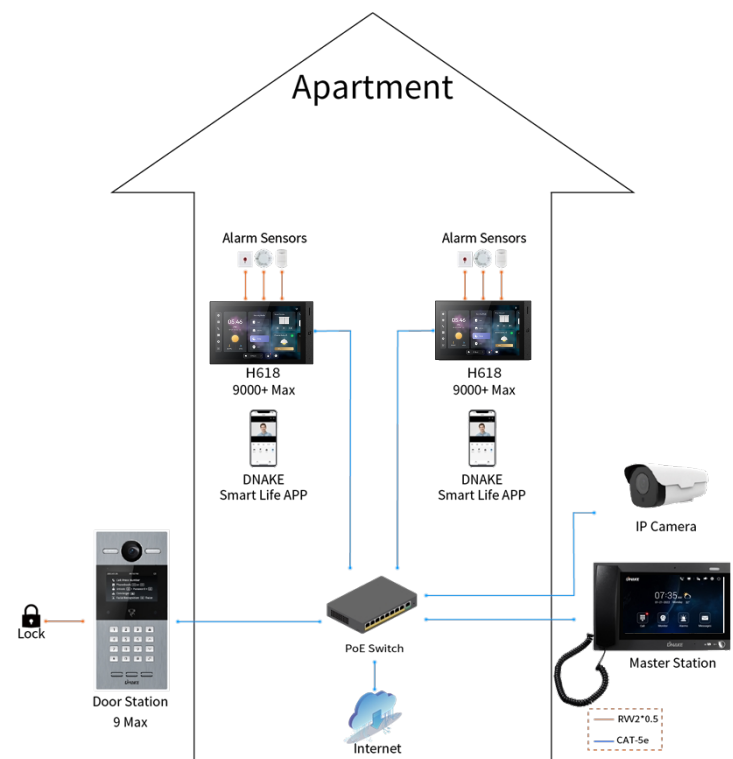

DEVICE WIRING

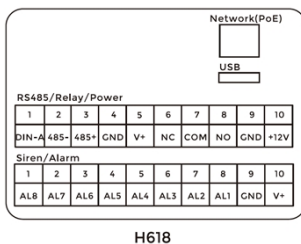

1. Network (PoE)

Standard RJ45 interface is used to be connected to the Master Station, Indoor Monitor and/or other network equipment.

PSE shall comply with IEEE 802.3af (PoE) and its output power not less than 15.4W and its output voltage not be less than 50V.

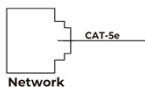

2. Power

The power interface of Indoor Monitor connects to 12V DC power.

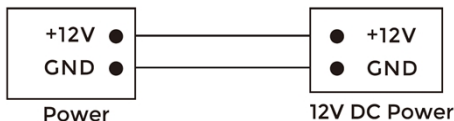

3. Relay Output

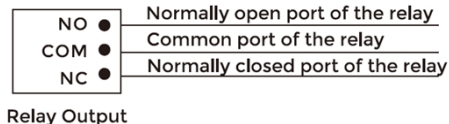

4. RS485

Enable to connect equipment with RS485 interface. RS485 interface can output 12V/100mA power supply. If RS485 equipment to be connected doesn't require the power supply, there is no need to connect to +12V.

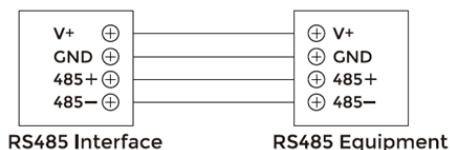

⚠ Warning!

1. When connecting to an inductive load device such as a relay or electromagnetic lock, you are recommended to use a diode 1A/400V (included in the accessories) in anti-parallel with the load device to absorb inductive load voltage peaks. The intercom will be better protected in this way.
2. The load current of the relay cannot be greater than 2A. See attached picture for more details.

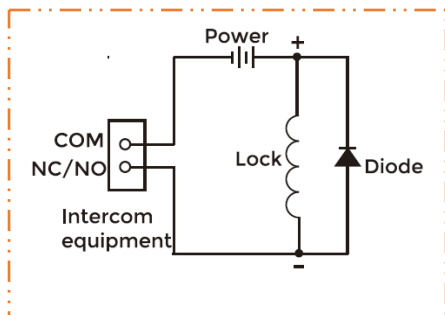

5. Siren/Alarm

Interface of alarm zones connects with normally-open or normally-closed switch. When the alarm zone is triggered, it will output 12V/100mA power.

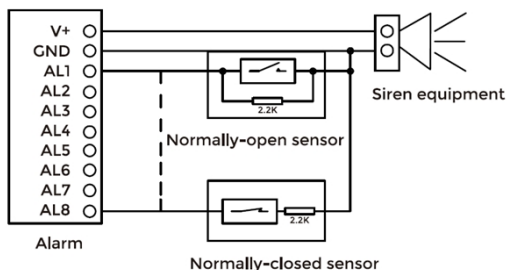

INSTALLATION

Surface Mounting-86 Mounting Box

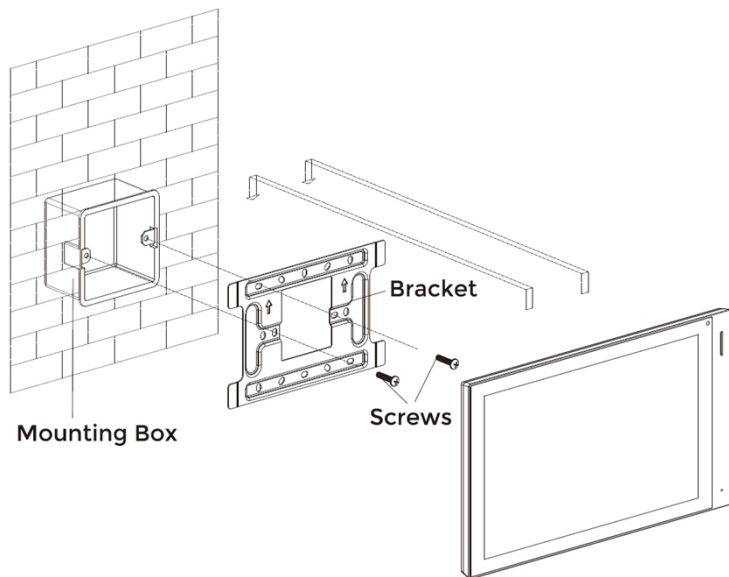

Product size: 264.3 × 160 × 11.8 mm
Surface Mounting size: 264.3 × 160 × 21.6 mm

Surface Mounting-118 Mounting Box

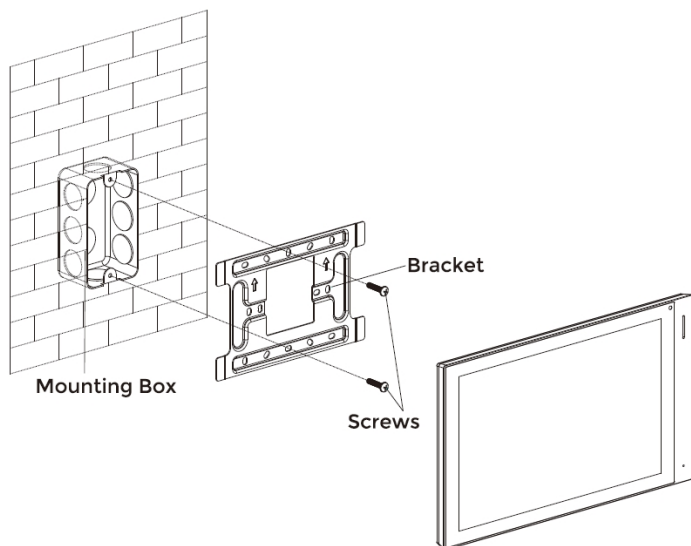

Product size: 264.3 × 160 × 11.8 mm
Surface Mounting size: 264.3 × 160 × 21.6 mm

Tips:

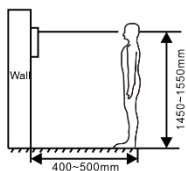

The camera should be 1450~1550mm above the ground.
The camera at this height can capture human face perfectly.

TROUBLESHOOTING

The Indoor Monitor cannot start up or power off automatically.

- Check whether it has power-failure, and power it on again

The Indoor Monitor display screen is too dim.

- Check whether the brightness and contrast settings of screen are correct.

No sound during the communication.

- Check whether the Indoor Monitor is set as mute mode, or the volume is set to the lowest.

The Indoor Monitor cannot monitor the Door Station.

- Other user is using the system, so you can use it once he/she finished the operation.

Multimedia files cannot be played normally.

- Check whether the system supports the file format. Please refer to the multimedia setting for details.

No response when clicking Indoor Monitor display screen.

- Press "Unlock" button for 5s, or slowly slide horizontally or vertically on the LCD to make touchscreen calibration. It needs to be calibrated.

Touchscreen responses slowly or cannot make calibration.

- Take down any protective paster, since it may affect identification and input for device;
- Ensure the finger is dry and clean when clicking touchscreen;
- Restart the device to clear any temporary software error.

The temperature of device is too high.

- Long-term use leads to high temperature. It's normal and will not affect the device's use life and performance.
-

SAFETY INSTRUCTION

In order to protect you and others from harm or your device from damage, please read the following information before using the device.

- Do not install the device in the following places:
- Do not install the device in high-temperature and moist environment or the area close to magnetic field, such as the electric generator, transformer or magnet.
- Do not place the device near the heating products such as electric heater or the fluid container.
- Do not place the device in the sun or near the heat source, which might cause discoloration or deformation of the device.
- Do not install the device in an unstable position to avoid the property losses or personal injury caused by the falling of device.

Guard against electric shock, fire and explosion:

- Do not use damaged power cord, plug or loose outlet.
- Do not touch the power cord with wet hand or unplug the power cord by pulling.
- Do not bend or damage the power cord.
- Do not touch the device with wet hand.
- Do not make the power supply slip or cause the impact.
- Do not use the power supply without the manufacturer's approval.
- Do not have the liquids such as water go into the device.

Clean Device Surface

- Clean the device surfaces with soft cloth dipped in some water, and then rub the surface with dry cloth.

Other Tips

- In order to prevent damage to the paint layer or the case, please do not expose the device to chemical products, such as the diluent, gasoline, alcohol, insect-resist agents, opacifying agent and insecticide.
- Do not knock on the device with hard objects.
- Do not press the screen surface. Overexertion might cause floppover or damage to the device.
- Please be careful when standing up from the area under the device.
- Do not disassemble, repair or modify the device at your own discretion.
- The arbitrary modification is not covered under warranty. When any repair required, please contact the customer service center.
- If there is abnormal sound, smell or fume in the device, please unplug the power cord immediately and contact the customer service center.
- When the device isn't used for a long time, the adaptor and memory card can be removed and placed in dry environment.
- When moving, please hand over the manual to new tenant for proper usage of the device.

 **EASY & SMART
INTERCOM SOLUTIONS**

 **DNAKE**