

DNAKE

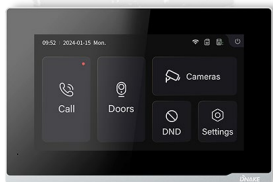

User Manual

DNAKE TWK01

REMARK

Please follow the user manual for correct installation and testing. If there is any doubt please call our tech-supporting and customer center.

Our company applies ourselves to reformation and innovation of our products. No extra notice for any change. The illustration shown here is only for reference. If there is any difference, please take the actual product as the standard.

The product and batteries must be handled separately from household waste. When the product reaches the end of service life and needs to be discarded, please contact the local administrative department and put it in the designated collection points in order to avoid the damage to the environment and human health caused by any disposal. We encourage recycling and reusing the material resources.

CATALOG

PRODUCT FEATURE	1
TECHNICAL PARAMETER	1
PACKAGE CONTENT	2
OVERVIEW	3
BASIC OPERATION	4
DEVICE SETTINGS.....	10
SYSTEM DIAGRAM	20
DEVICE WIRING	21
INSTALLATION.....	22
TROUBLESHOOTING.....	26
SAFETY INSTRUCTION	27
FCC Warning	28

PRODUCT FEATURE

1. Plug & Play
2. Quick Start Wizard
3. Wi-Fi connection
4. One-touch calling
5. Remote unlocking
6. CCTV integration

TECHNICAL PARAMETER

Indoor Monitor E217W-2

Power Supply: DC 24V

Standby Power: 5 W

Rated Power: 9.5 W

Display: 7-inch TFT LCD

Screen: Capacitive touchscreen

Resolution: 1024 x 600

Working Temperature: -10°C to +55°C

Storage Temperature: -10°C to +70°C

Working Humidity: 10% to 90% (non-condensing)

Door Station S212-2

Power Supply: Powered by Indoor Monitor

Standby Power: 3.5 W

Rated Power: 12 W

Video Resolution: 1280 x 720



















Working Temperature: -40°C to +55°C

Storage Temperature: -40°C to +70°C

Working Humidity: 10% to 90% (non-condensing)

PACKAGE CONTENT

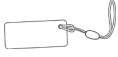
MODEL: TWK01

				
E217W-2	Bracket	PM4×20 (2 pcs)	Wires	Power supply
				
S212-2	Wiring Cover	Sealing Plug of Wiring Port	Junction Pressing	PM2.5×6 (4 pcs)
				
Rear Cover	Screw Fixing Seat (2 pcs)	PA4×30 (2 pcs)	PM4×20 (2 pcs)	FM3×4.5 (2 pcs)
				
Wrench Screw	Stickers (6 pcs)	IC cards (5 pcs)	User Manual	

OVERVIEW

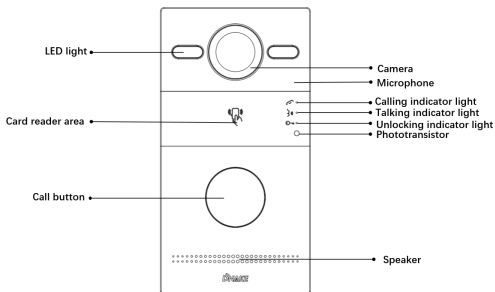
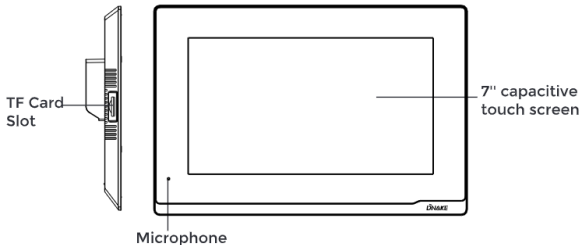

Note:

Calling indicator light: The 1st indicator light will activate if the call button is pressed.

Talking indicator light: The 2nd indicator light will activate if the call is picked up or the Door Station is being actively monitored.

Unlocking indicator light: The 3rd indicator light activates for 3 seconds when the door is unlocked.

Relay Outputs: Supports 2 relay outputs.

BASIC OPERATION

1. Onboarding

1.1. Language 1/3

Language is the first setting. We have 16 kinds of languages (Chinese Simplified, Chinese Traditional, English, Spanish, German, Polish, Russian, Turkish, Hebrew, Arabic, Portuguese, French, Italian, Slovak, Vietnamese, and Dutch) for customers to choose from.

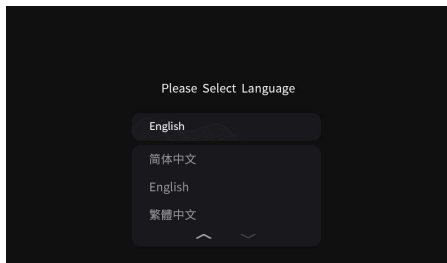

1.2. Indoor Monitor Mode 2/3

1. Is it your first Indoor Monitor?

If yes, please select "Main Indoor Monitor", this Indoor Monitor will be regarded as the main one. If not, your first Indoor Monitor will be the main one while this one will be the subordinate one.

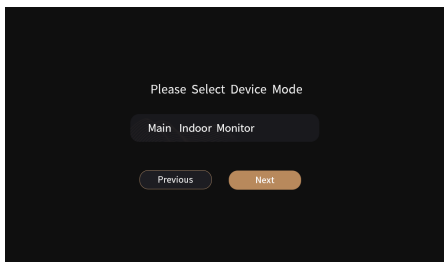

1.3. Select Door Station 3/3

Door Station should be connected to the Indoor Monitor's when Indoor Monitor is searching Door Station.



Select Door Station and MAC of Door Station will appear. Click MAC of Door Station to Sync. Then the settings are completed.

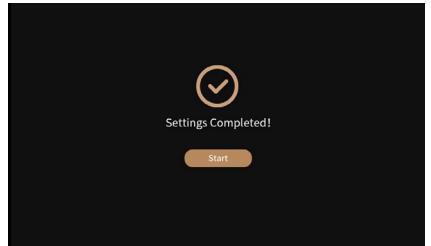
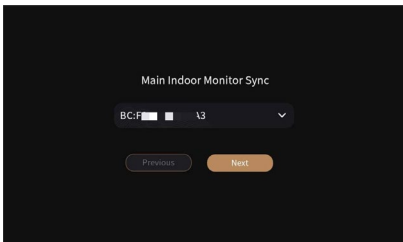

2. Call Indoor Monitor by Door Station

2.1. Call Indoor Monitor by Door Station

1. Try to call Indoor Monitor. Press the Button on Door Station to make this call.



2. You can answer, reject, open the door, or speak with the visitor.



3. Monitor Door Station on Indoor Monitor

3.1. Monitor Door Station on Indoor Monitor

1. Press Doors on Indoor Monitor to monitor Door Station.

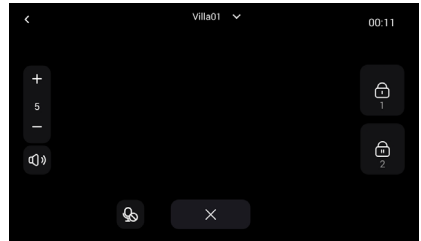
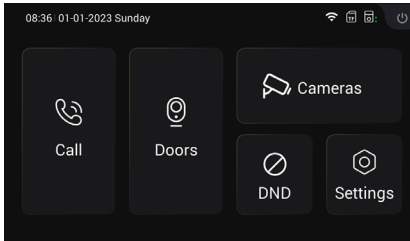

4. Add Subordinate Indoor Monitor

4.1. Add subordinate Indoor Monitor

1. After having added first Indoor Monitor successfully, resident can add subordinate Indoor Monitors to it.

Step 1: Connect subordinate Indoor Monitor to the first Indoor Monitor.

Step 2: Follow the guide on it. Select language.

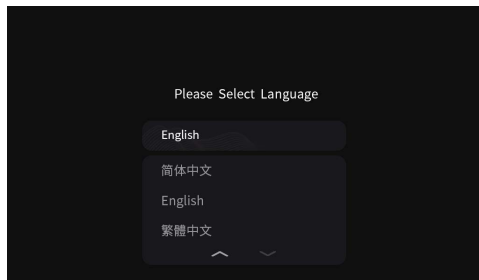

Step 3: Choose Sub Indoor Monitor.

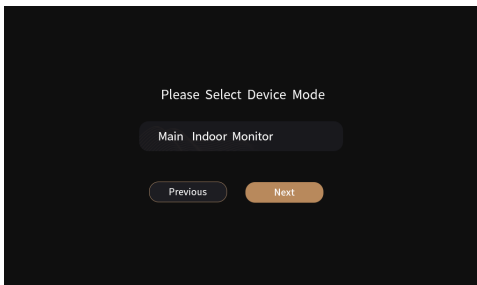

Step 4: MAC of first Indoor Monitor will appear. Click MAC of first Indoor Monitor to Sync.

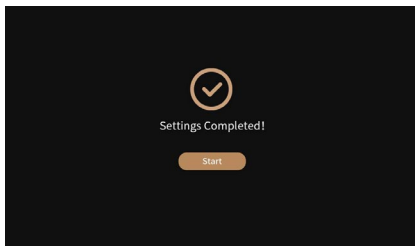
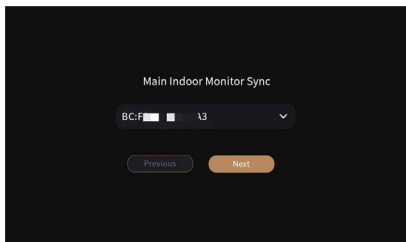

5. IP Cameras Monitoring

5.1. IP cameras monitoring

1. Connect the Ethernet cable to both IP Camera and Indoor Monitor. Please keep them under the same LAN.

2. Add IP Camera to the Indoor Monitor on the device:

Step 1: You can click Cameras to enter the page about IP cameras.

Step 2: Name IP camera and type in URL after clicking “+” icon. URL contains the Name and RTSP URL. Make sure the URL of the IP Camera is right. Please get your IPC RTSP stream URL from Internet or IPC provider.

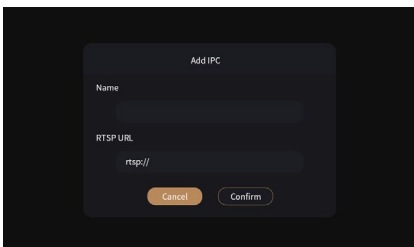
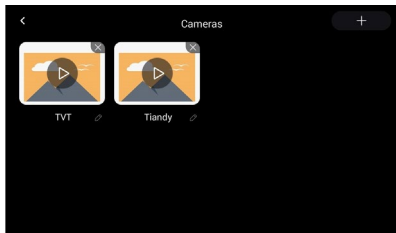
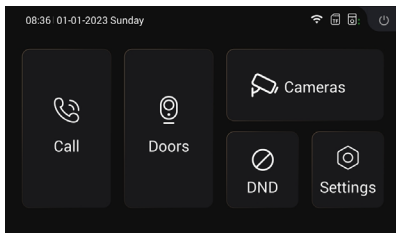

The followings are introductions about the buttons to control monitoring of cameras:

The name of IP Camera is on the top for switching the cameras.

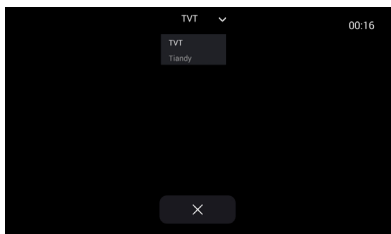

6. DND

Click DND icon to enable do not disturb function. No calls can call in. Users can set DND to turn on whole day or a period of time. The settings of DND you can find on Settings > DND page.

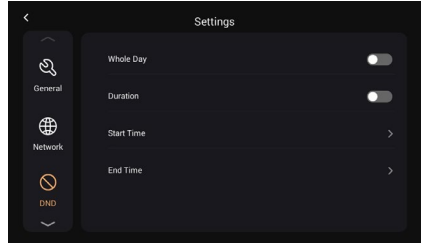
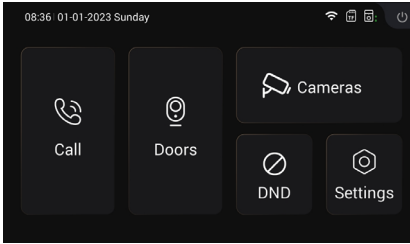

DEVICE SETTINGS

1. General

1.1. Display

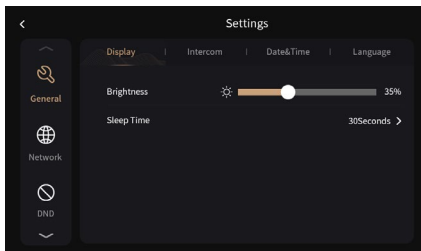

Brightness:	Screen brightness adjustment;
Sleep Time:	Screen sleep time (15s, 30s, 1min, 2mins, 5mins, 20mins, 30mins);

1.2. Intercom

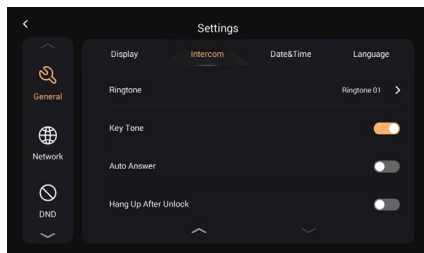
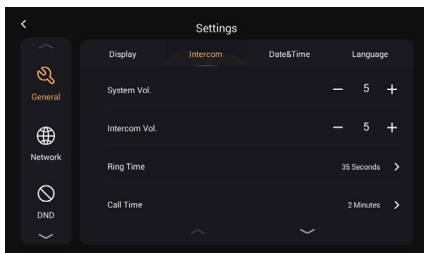

System Vol:	Volume of System can be set from 1 to 6. Volume 6 is the maximum volume (Key tone);
Intercom Vol:	Volume of Intercom can be set from 1 to 6. Volume 6 is the maximum volume (Call volume);
Ring Time	The ring will be ended automatically after a period of time (10s, 20s, 35s, 45s, 60s, 90s, 120s)
Call Time:	The call will be ended automatically after a period of time (2m, 5m, 10m, 20m, 30m);
Ringtone:	The ringing sound (Ringtone 01-04);
Key Tone:	The keytone (Enable or disable);
Auto Answer:	Pick up automatically when receiving a call;
Hang Up After Unlocking:	Once the door is unlocked, the call will be finished automatically after 5s.

1.3 Date & Time

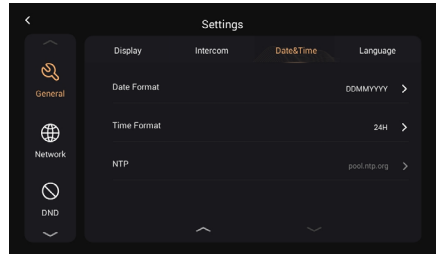
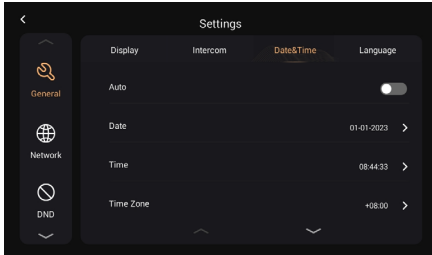

Auto:	Enable to synchronize computer time;
Date&Time:	Date and time can be set manually;
Time Zone:	A region that observes a uniform standard time;
Date Format:	3 time formats supported (YYYY-MM-DD, DD-MM-YYYY, MM-DD-YYYY);
Time Format:	Select 12H or 24H format to display on the device;
NTP:	Network Time Protocol (NTP) is a protocol used to synchronize NTP time;

1.4 Language

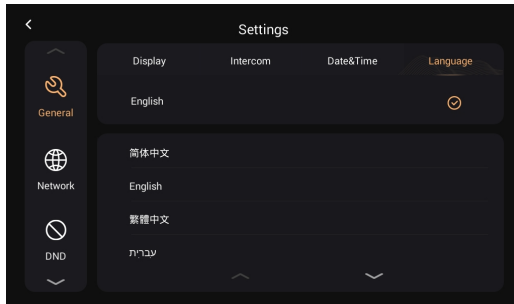

Language:	16 languages supported (简体中文, English, 繁體中文, עברית, Deutsch, Español, Türk, Tiếng Việt, Nederlands, Português, Polski, Русский, عربي, Français, Italiano, slovenský);
-----------	---

2. Network

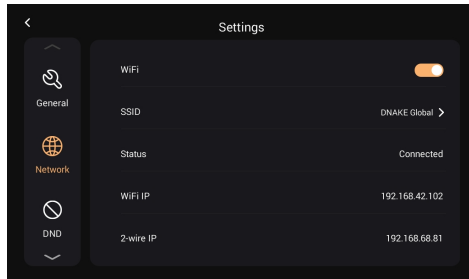

WiFi:	Enable WiFi to connect network;
SSID:	Choose the network to connect;
Mask:	Subnet mask;
Status:	The Status of WiFi, connected or disconnect;
WiFi IP:	The WiFi IP of the device connect;
2-wire IP:	The main Indoor Monitor's IP address is 192.168.68.81; Sub Indoor Monitor's IP address is 192.168.68.82.

3. DND

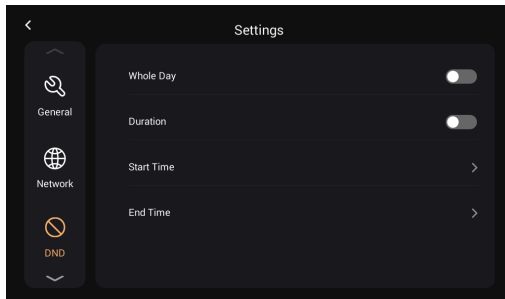

DND:	DND is disabled by default. Whole Day: when DND is enabled, it will reject calls for the whole day. Duration: when DND is enabled, it will reject calls during this time.
------	---

4. Doors

4.1. Upgrade and Reset

You can upgrade and reset Door Station on this page by clicking the arrow icon (Upgrade) and circle icon (Reset).

Upgrade method: Put the FW on a folder named “doorUpgrade” on TF card, then click arrow icon here.

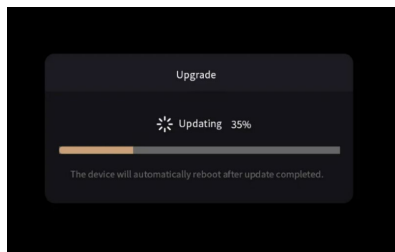
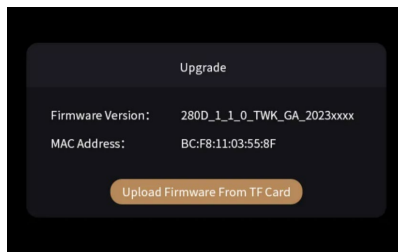

4.2. Manage other cards by admin card

- a) Add Master card: Tap your card on Door Station after you click “Read”, this card is your Master card.
- b) Add other cards: Tap your Master card once and then tap other cards immediately. Other cards you have tapped can be used to open the door. Tap Master card again to finish.
- c) Delete other cards one by one: Tap your Master card twice and then tap other cards immediately. Other cards you have tapped will be deleted. Tap Master card again to finish.
- d) Delete all other cards: Tap your Master card five times. All the other cards will be deleted.

Please note that Master card can only be used to manage cards. It cannot be used to open the door.

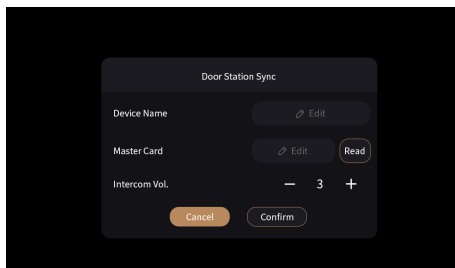
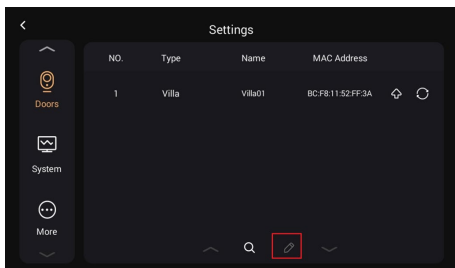

5. System

5.1. Version

You can upgrade and Indoor Monitor on this page.

Upgrade method: Put the FW on a folder named “Upgrade” on TF card, then click Upgrade here.

And there is information about Indoor Monitor, including IP address, MAC address and TF card.

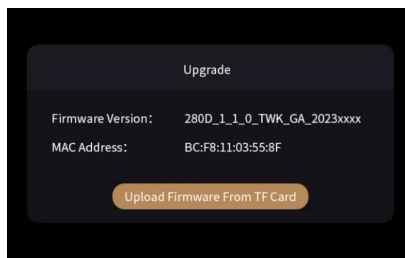
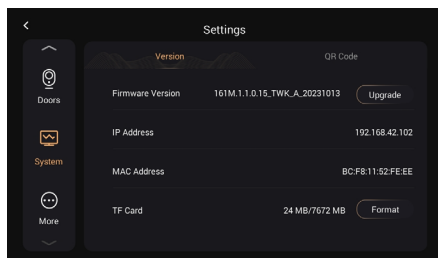

5.2. QR code

5.2.1. Download Smart Life app

Resident can also download the Smart Life app by searching for Smart Life in app store, Google Play Store or by scanning the following QR code.

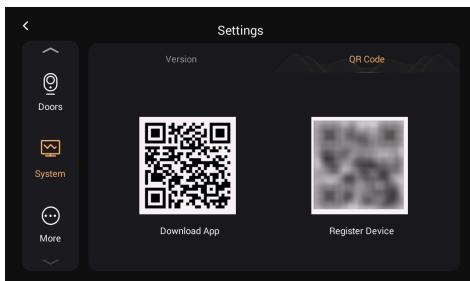

5.2.2. Register, log in

1. Open the Smart Life app and tap Sign Up. In the User Agreement and Privacy Policy dialog box, carefully read the privacy policy and agreement and tap Agree to go to the account registration page.

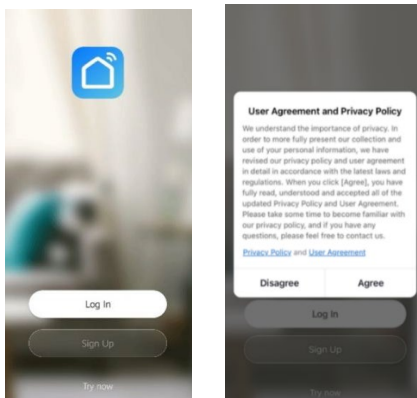

2. Enter resident's email address and tap Get Verification Code. The country or region on the registration page is the same as that resident set in the mobile phone. Resident can also manually change the country or region before registration.
3. On the Enter Verification Code page, enter the verification code. On the Set Password page, set the password as per instructions and tap Done.

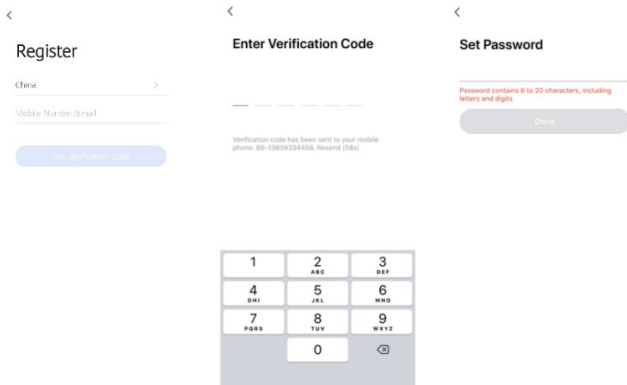

5.2.3. Scan QR code

1. License of Smart Life app will be filled in Indoor Monitor before delivery.

Step 1: Go to Settings > System page.

Step 2: Select the QR code.

Step 3: Scan QR code. One QR code can only be bound to one phone but resident can share resident's authority to its family members up to 20 users.

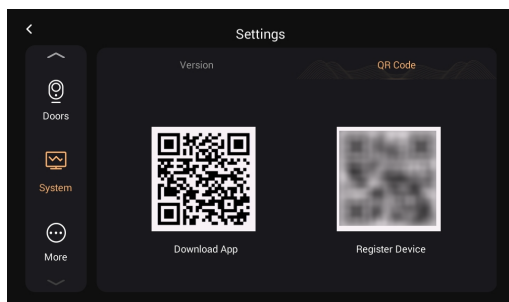

2. Congratulations. Door Station is successfully connected to resident's phone.

3. After you complete the above steps, the Smart Life app will automatically enter the interface of monitor. You can make a video call to Door Station and unlock remotely on the smart phone. If Door Station is calling in, Indoor Monitor and Smart Life App can ring at the same time, and the mobile phone APP can answer the call and unlock remotely. Smart Life App can also monitor and unlock Door Station.

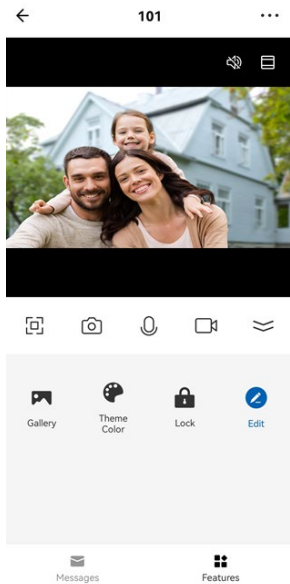

- Switch to full screen
- Take a screenshot
- Record a video
- Expand more
- Messages
- Features (Gallery, Theme Color, Lock, Edit)
- Gallery
- Theme Color (Light Mode & Dark Mode)
- Lock remotely
- Edit (Button Management)

a) Rename devices

1. After scanning the device, resident will see the reminder (Added successfully).

In this page, resident can edit the name and room of this device.

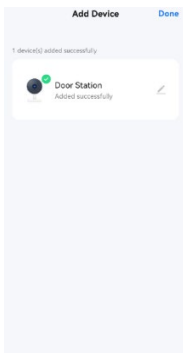

2. After the device is added, resident can customize the device name. The following steps and pictures are here for reference.

Step 1: Back to the home page and click the device to rename.

Step 2: Click Edit in the upper right corner.

Step 3: Select the icon.

Step 4: Click Name.

Step 5: Rename device.

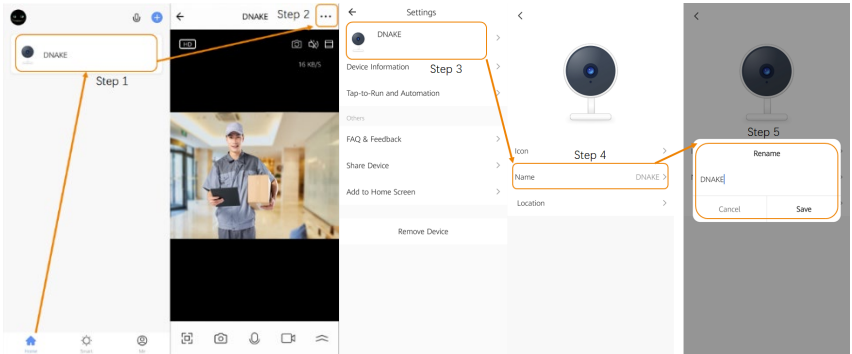

b) Share devices

You can create a home to share your devices in this group. The following steps and pictures are here for reference.

Step 1: Go to Me page and then open Home Management.

Step 2: Select Alexa My Home or Create a Home.

Step 3: In the Home Setting page, you can rename, locate, or share your device.

Step 4: Wait for new members to accept your invitation.

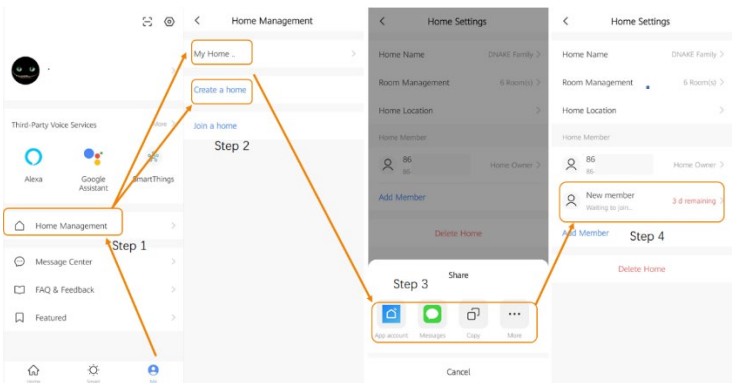

6. More

6.1 Device

This page is about some parameters about Indoor monitor. (The default password is 123456.)

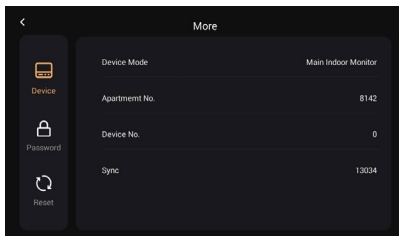
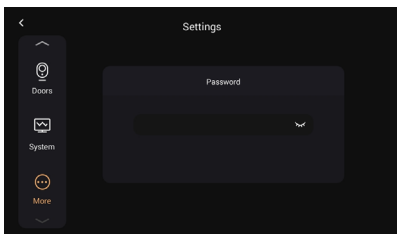

6.2 Password

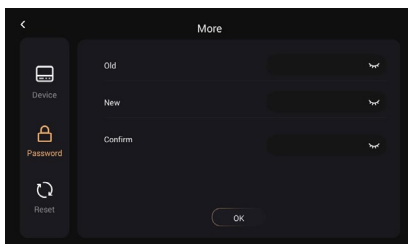

Old Password:	Current administrator password of the Device (Default 123456);
New Password:	New administrator password of the Device;
Confirm Password:	Confirm administrator password of the Device;

6.3 Reset

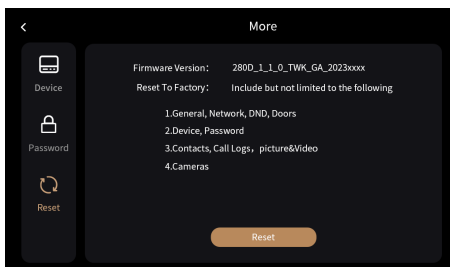

Reset:	Reset to factory default;
--------	---------------------------

SYSTEM DIAGRAM

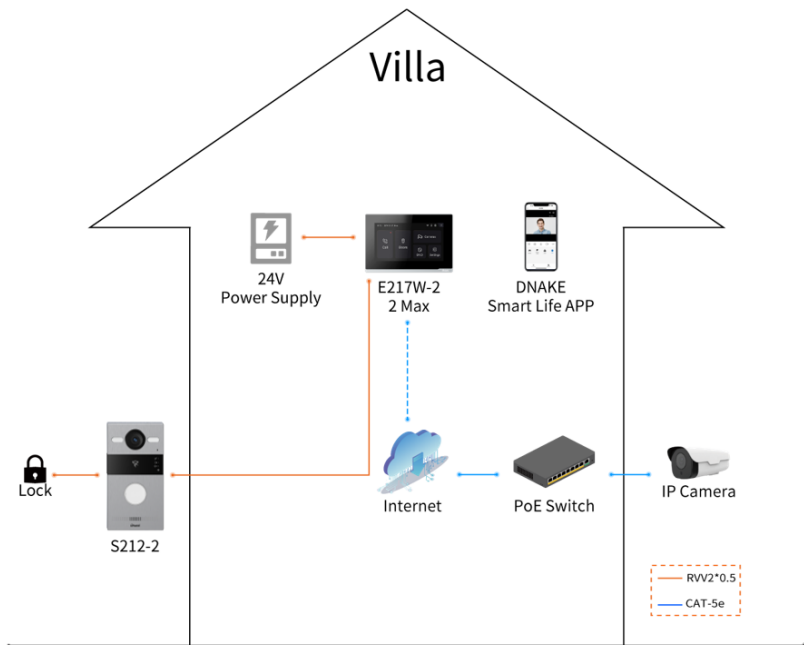

DEVICE WIRING

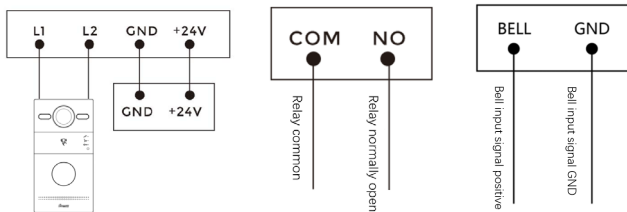

E217W-2

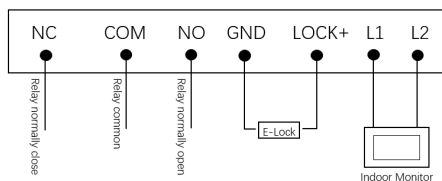

S212-2

1. Power

Power interface of Indoor Monitor connects with 24V 2-wire adapter.

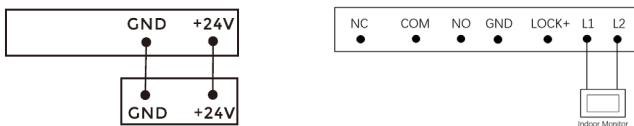

E217W-2

S212-2

2. Switching Value Output (S212-2)

Connect to the lock module (an independent power supply is necessary for the lock).

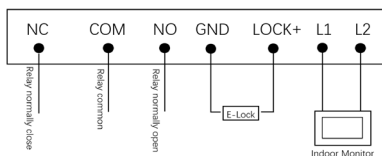

INSTALLATION

Surface Mounting-86 Mounting Box

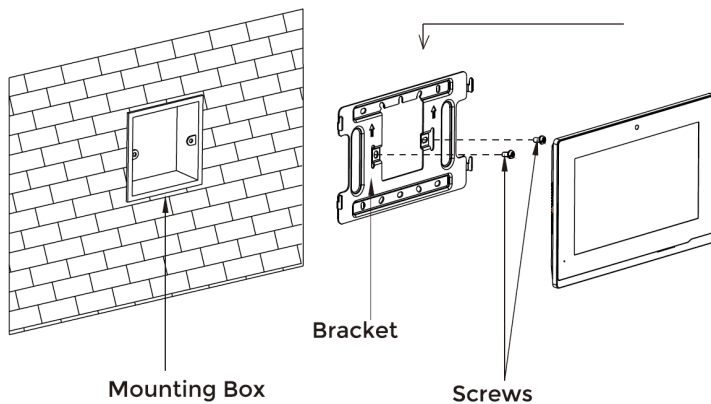

Product size: 195 × 130 × 14.5 mm

Installation of Wiring Cover

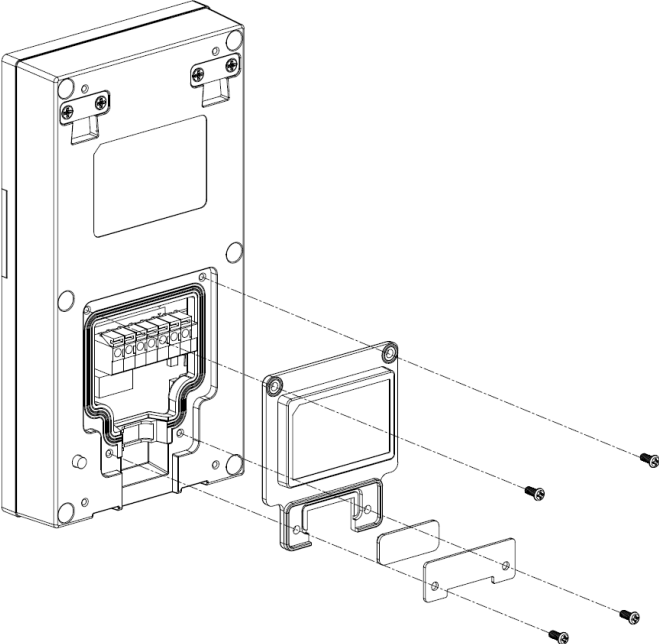

Surface Mounting-86 Mounting Box

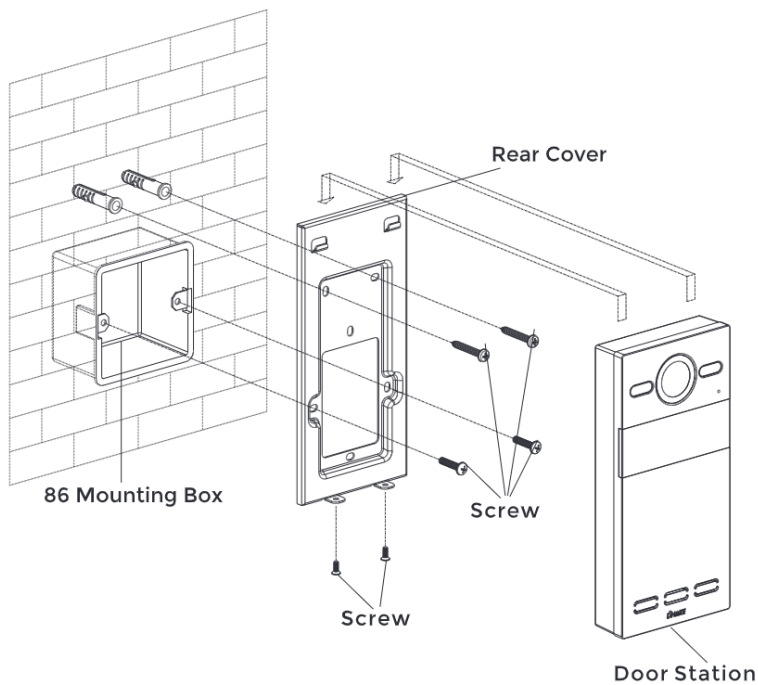

Product size: 88 × 168 × 32.5 mm
Surface Mounting size: 88 × 168 × 34 mm

Surface Mounting-118 Mounting Box

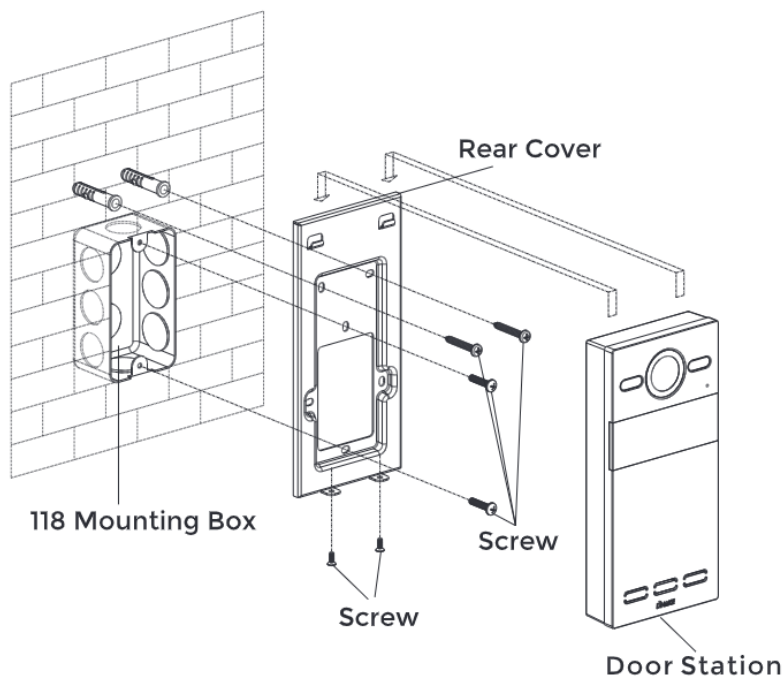

Product size: 88 × 168 × 32.5 mm
Surface Mounting size: 88 × 168 × 34 mm

Tips:

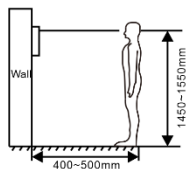

The camera should be 1450~1550mm above the ground.
The camera at this height can capture human face perfectly.

TROUBLESHOOTING

The Indoor Monitor cannot start up or power off automatically.

- Check whether it has power-failure, and power it on again

The Indoor Monitor display screen is too dim.

- Check whether the brightness and contrast settings of screen are correct.

No sound during the communication.

- Check whether the Indoor Monitor is set as mute mode, or the volume is set to the lowest.

The Indoor Monitor cannot monitor the Door Station.

- Other user is using the system, so you can use it once he/she finished the operation.

Multimedia files cannot be played normally.

- Check whether the system supports the file format. Please refer to the multimedia setting for details.

No response when clicking Indoor Monitor display screen.

- Press "Unlock" button for 5s, or slowly slide horizontally or vertically on the LCD to make touchscreen calibration. It needs to be calibrated.

Touchscreen responses slowly or cannot make calibration.

- Take down any protective paster, since it may affect identification and input for device;
- Ensure the finger is dry and clean when clicking touchscreen;
- Restart the device to clear any temporary software error.

The temperature of device is too high.

- Long-term use leads to high temperature. It's normal and will not affect the device's use life and performance.
-

SAFETY INSTRUCTION

In order to protect you and others from harm or your device from damage, please read the following information before using the device.

- Do not install the device in the following places:
- Do not install the device in high-temperature and moist environment or the area close to magnetic field, such as the electric generator, transformer or magnet.
- Do not place the device near the heating products such as electric heater or the fluid container.
- Do not place the device in the sun or near the heat source, which might cause discoloration or deformation of the device.
- Do not install the device in an unstable position to avoid the property losses or personal injury caused by the falling of device.

Guard against electric shock, fire and explosion:

- Do not use damaged power cord, plug or loose outlet.
- Do not touch the power cord with wet hand or unplug the power cord by pulling.
- Do not bend or damage the power cord.
- Do not touch the device with wet hand.
- Do not make the power supply slip or cause the impact.
- Do not use the power supply without the manufacturer's approval.
- Do not have the liquids such as water go into the device.

Clean Device Surface

- Clean the device surfaces with soft cloth dipped in some water, and then rub the surface with dry cloth.

Other Tips

- In order to prevent damage to the paint layer or the case, please do not expose the device to chemical products, such as the diluent, gasoline, alcohol, insect-resist agents, opacifying agent and insecticide.
- Do not knock on the device with hard objects.
- Do not press the screen surface. Overexertion might cause floppover or damage to the device.
- Please be careful when standing up from the area under the device.
- Do not disassemble, repair or modify the device at your own discretion.
- The arbitrary modification is not covered under warranty. When any repair required, please contact the customer service center.
- If there is abnormal sound, smell or fume in the device, please unplug the power cord immediately and contact the customer service center.
- When the device isn't used for a long time, the adaptor and memory card can be removed and placed in dry environment.
- When moving, please hand over the manual to new tenant for proper usage of the device.

FCC Warning

This device complies with Part 15 of the FCC Rules. Operation is subject to the following two conditions:

(1) This device may not cause harmful interference, and (2) this device must accept any interference received, including interference that may cause undesired operation.

NOTE 1: This equipment has been tested and found to comply with the limits for a Class B digital device, pursuant to part 15 of the FCC Rules. These limits are designed to provide reasonable protection against harmful interference in a residential installation. This equipment generates uses and can radiate radio frequency energy and, if not installed and used in accordance with the instructions, may cause harmful interference to radio communications. However, there is no guarantee that interference will not occur in a particular installation. If this equipment does cause harmful interference to radio or television reception, which can be determined by turning the equipment off and on, the user is encouraged to try to correct the interference by one or more of the following measures:

- Reorient or relocate the receiving antenna.
- Increase the separation between the equipment and receiver.
- Connect the equipment into an outlet on a circuit different from that to which the receiver is connected.
- Consult the dealer or an experienced radio/TV technician for help.

NOTE 2: Any changes or modifications to this unit not expressly approved by the party responsible for compliance could void the user's authority to operate the equipment.

RF exposure statement

Indoor Monitor complies with FCC radiation exposure limits set forth for an uncontrolled environment. This equipment should be installed and operated with minimum distance 20cm between the radiator & your body.

Door Station complies with the FCC radiation exposure limits set forth for an uncontrolled environment. This transmitter must not be co-located or operating in conjunction with any other antenna or transmitter.

 **EASY & SMART
INTERCOM SOLUTIONS**